



# Product Specifications

Customer :	
Model No. :	NTSM170 V4



**Features :**

- ★ 17" 1280x1024 (SXGA+ 5:4/4:3) Resolution
- ★ Resistive/SCAP Touch Options
- ★ Metal Cabinet with Diverse Combine Options
- ★ Made in Taiwan, 3 Years Warranty
- ★ Designed for All Environments
- ★ Optional High Brightness/Sunlight Readable
- ★ Optional AG/AR/AF Film
- ★ Optional 9~36VDC Power Input Options
- ★ Optional Video Input Connectors (VGA/DVI/HDMI/DP)
- ★ Optional Software Remote Control by RS232
- ★ Optional Auto Dimming Function (with Light Sensor)







Side Brackets



Desktop Stand



Wall Mounting

			
BSMI	CE	FCC	RoHS
<b>Compliance</b>			

Records of Revision			
Vision	Modifying	Old Description	New Description
v1812.1	Preliminary specification		

**General Specifications**

**TFT-LCD Specifications**

Full Model No.	NTSM170XX-XXXXXXX-400 *	Response Time	5 msec
Screen Diagonal	432 mm (17.0 inch)	Backlight Unit	LED (white LED)
Display Area	337.9x270.3 mm	Viewing Angle (L/R,U/D)	170° / 160° (TN)
Resolution	1280x1024 (SXGA+)	Backlight Life Time	30000 HRS
Pixel Pitch	0.264x0.264 mm	Operating Temp.	0~50°C
Contrast Ratio	1000:1	Storage Temp.	0~50°C
Display Ratio	5:4/4:3	Surface Treatment	Anti-glare, Hardness 3H
Support Color	16.7M Color		

\* Depends on specifications and options.

**Brightness Options**

	Brightness	Model Number	Application
<b>Standard</b>	250nits	NTSM170NX-XXXXXXX-400	<b>General (Indoor Environment)</b>
Option 1	1000nits	NTSM170AX-XXXXXXX-400	Outdoor Environment
Option 2	1500nits	NTSM170FX-XXXXXXX-400	Sunlight Readable

**Video Input Options**

	Connectors	Model Number
<b>Standard</b>	VGA+DVI	NTSM170XX-XXXXX4X-400
Option 1	VGA+HDMI	NTSM170XX-XXXXX2X-400
Option 2	VGA+HDMI+DP	NTSM170XX-XXXXX3X-400



Standard / VGA+DVI



Option 1 / VGA+HDMI



Option 2 / VGA+HDMI+DP

**Power Input Options**

	Description	Model Number
<b>Standard</b>	12VDC , DC Power Jack $\Phi$ 2.1mm	NTSM170XX-XXXXXX1-400
Option 1	12VDC , DC Lockng Power Jack $\Phi$ 2.1mm *	NTSM170XX-XXXXXX2-400
Option 2	9~36VDC , Phoenix Terminal Block **	NTSM170XX-XXXXXXP-400



Option 1 / Locking Power Jack/Plug



Option 2 / Phoenix Terminal Block/Plug

Audio System		
	Description	Connector
Audio Input	<b>Stereo</b>	<b>TRS Connector Φ3.5mm (Earphone Jack)</b>
Speakers	<b>2W x2</b>	



Audio input



Speakers

Cabinet Options		
	Description	Model Number
<b>Standard</b>	<b>Galvanized steel (SECC)</b>	<b>NTSM170XX-XXXSXXX-400</b>
Option 1	Stainless Steel	NTSM170XX-XXXLXXX-400
Option 2	Aluminum	NTSM170XX-XXXAXXX-400

Fan Options		
	Description	Model Number
<b>Standard</b>	<b>Fanless</b>	<b>NTSM170XX-XXXXOXX-400</b>
Option	7 Blades/1.2W/4000r.p.m Max.10.96CFM/28.3dB	NTSM170XX-XXXXEXX-400



OSD Control Options		
	Item	Description
<b>Standard</b>	<b>Button</b>	<b>Rear Physical Button</b>
Option 1	Software Remote Control	Software Remote Control by RS232/Serial Port
Option 2	Auto Dimming	Auto Brightness Adjusting by Built-in Light Sensor

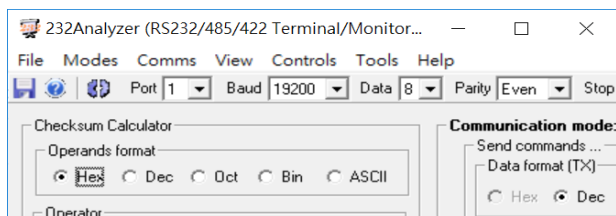

\* Software Remote Control

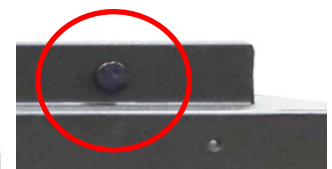
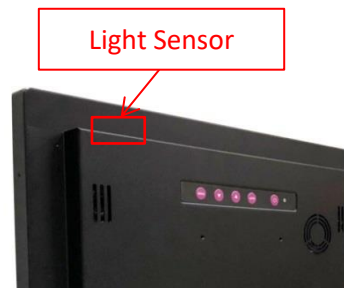

Supported OS	
OS	Version
Windows	<b>Win10, Win8, Win7, Vista, XP, Embedded XP, Win2000, CE.NET 4.x ↑</b>
Linux	<b>Kernel 2.6.24 ↑</b>
Android	<b>3.0 ↑</b>
Mac	<b>10.5.x ↑ (Intel CPU)</b>

Touch Options		
	Description	Model Number
<b>Standard</b>	<b>Resistive Touch</b>	<b>NTSM170X<sub>5</sub>-XXXXXXX-400</b>
Option 1	Non-touch	NTSM170X <sub>0</sub> -XXXXXXX-400
Option 2	Surface Capacitive	NTSM170X <sub>C</sub> -XXXXXXX-400

Resistive Touch Model			
Touch Screen	<b>5 Wire Resistive Touch</b>	Transparency	<b>80% ±5%</b>
Allowed touch points	<b>1 point</b>	Surface Treatment	<b>Anti-glare &lt;15%</b>
Interface	<b>USB/RS232</b>	Hardness	<b>≥3H</b>
Accuracy	<b>98.50%</b>		

Surface Capacitive Touch Model			
Touch Screen	<b>Surface Capacitive</b>	Transparency	<b>≥92% ±3%</b>
Allowed touch points	<b>1 point</b>	Surface Treatment	<b>Anti-glare &lt;7%</b>
Interface	<b>USB/RS232</b>	Hardness	<b>≥9H</b>
Accuracy	<b>99.00%</b>		

Surface Film Options	
<b>Standard</b>	<b>(none)</b>
Option	Anti-Glare (AG Film)
Option	Anti-Reflective (AR Film)
Option	Anti-Fouling/FingerPrint (AFP Film)
Option	Anti-Spy (AS Film)
Option	UV-Cut (UV Film)



Accessories		
Item	Description	Quantity
VGA Cable	<b>D-Sub 15Pin Male to Male , 1.2 Meter</b>	<b>1</b>
Audio cable	<b>3.5mm Headset Jack , Male to Male , 1.2 Meter</b>	<b>1</b>
AC-DC Adapter	<b>4.16A/12V with CE/FCC/CCC/UL/RoHS/PSE/JET Certification</b>	<b>1</b>
Power cord	<b>*(depends on Country)</b>	<b>1</b>
USB Cable	<b>A type , Male to Male , 1.5 Meter *(only for touch monitor)</b>	<b>1</b>



**Physical Specifications**

Dimension (Max)	<b>371x308x42(±1)mm</b>	Net Weight	<b>≦ 3.72 KG</b>
VESA Mounting	<b>100x100 mm</b>	Gross Weight	<b>≦ 5.4 KG</b>

**Outward and Dimensions**

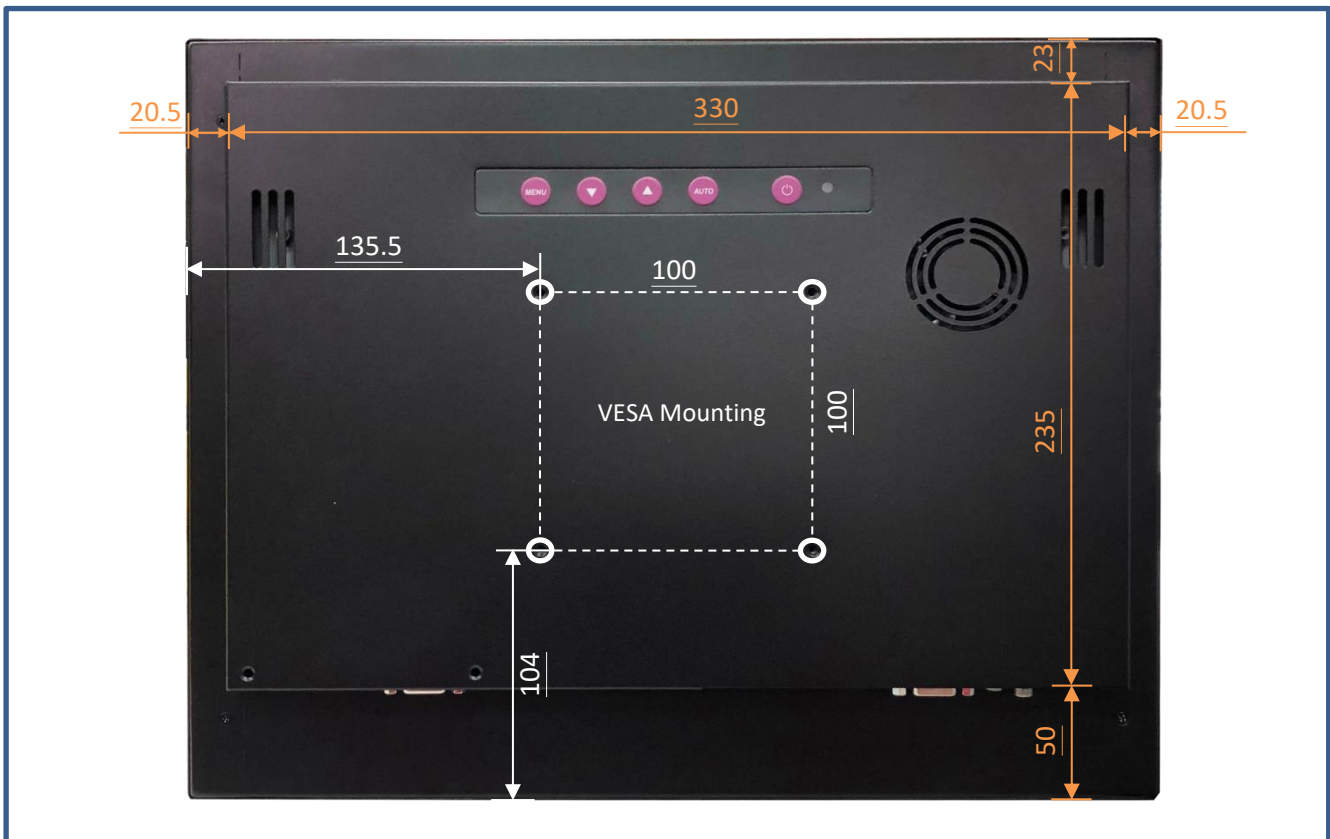
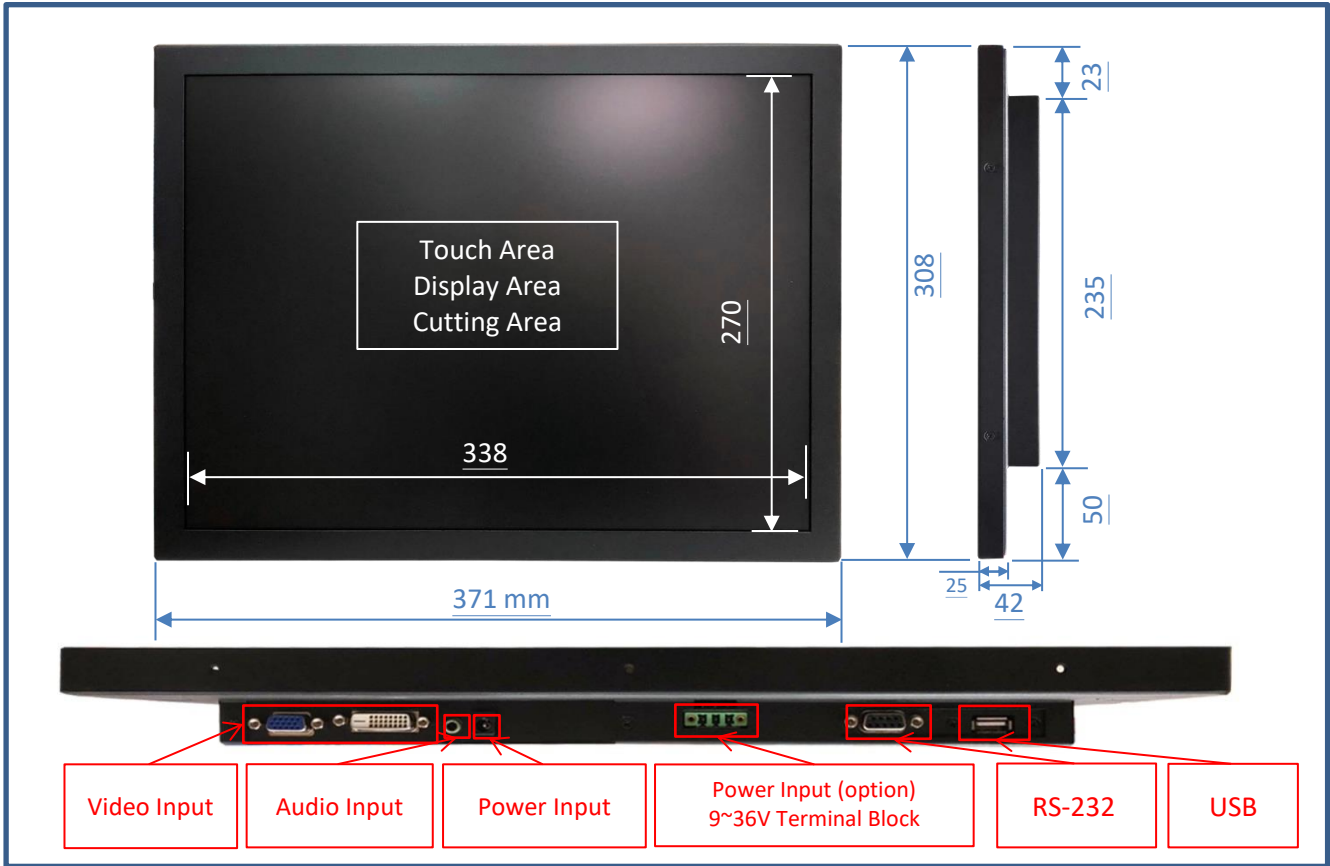

**Optional Accessories (Desktop Stand)**

Item	B Stand	Part No.	DST-0B002/DST-1B002
Mounting Pattern	100x100 / 75x75 mm	Dimension (WxHxD)	203x275x227 mm
Material	Steel/Plastic/Aluminum	Net Weight	1.8 KG
Tilt(Hinge)	-2° ~+180°	Support Max. Weight	15 KG

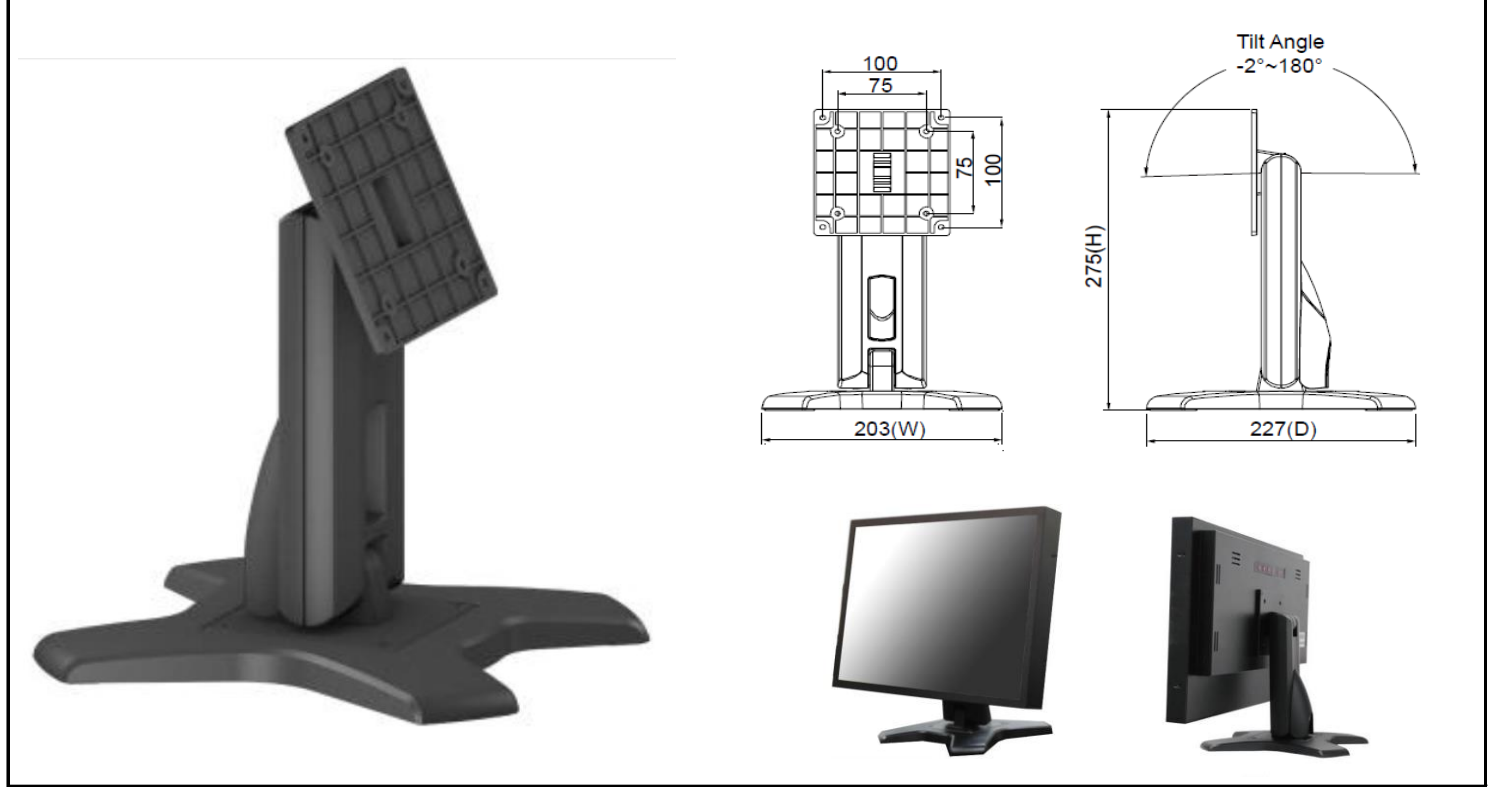

Item	Z Stand	Part No.	DST-0BZ01/DST-1BZ01
Mounting Pattern	100x100 / 75x75 mm	Dimension (WxHxD)	190x240x41.6
Material	SECC	Net Weight	2.6 KG
Tilt(Hinge)	±360°	Support Max. Weight	15 KG

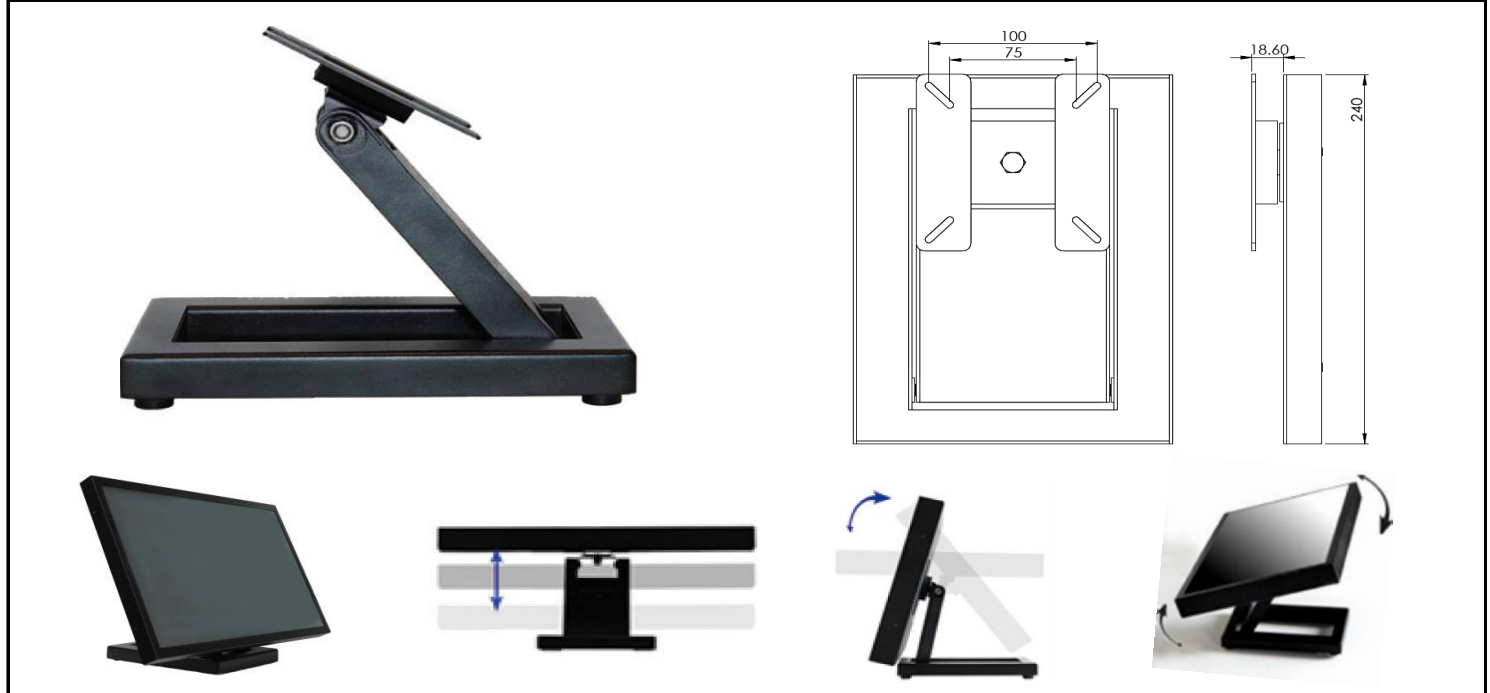

Optional Accessories (Open-frame Brackets)

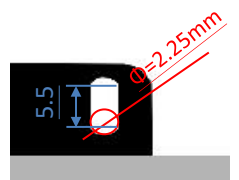
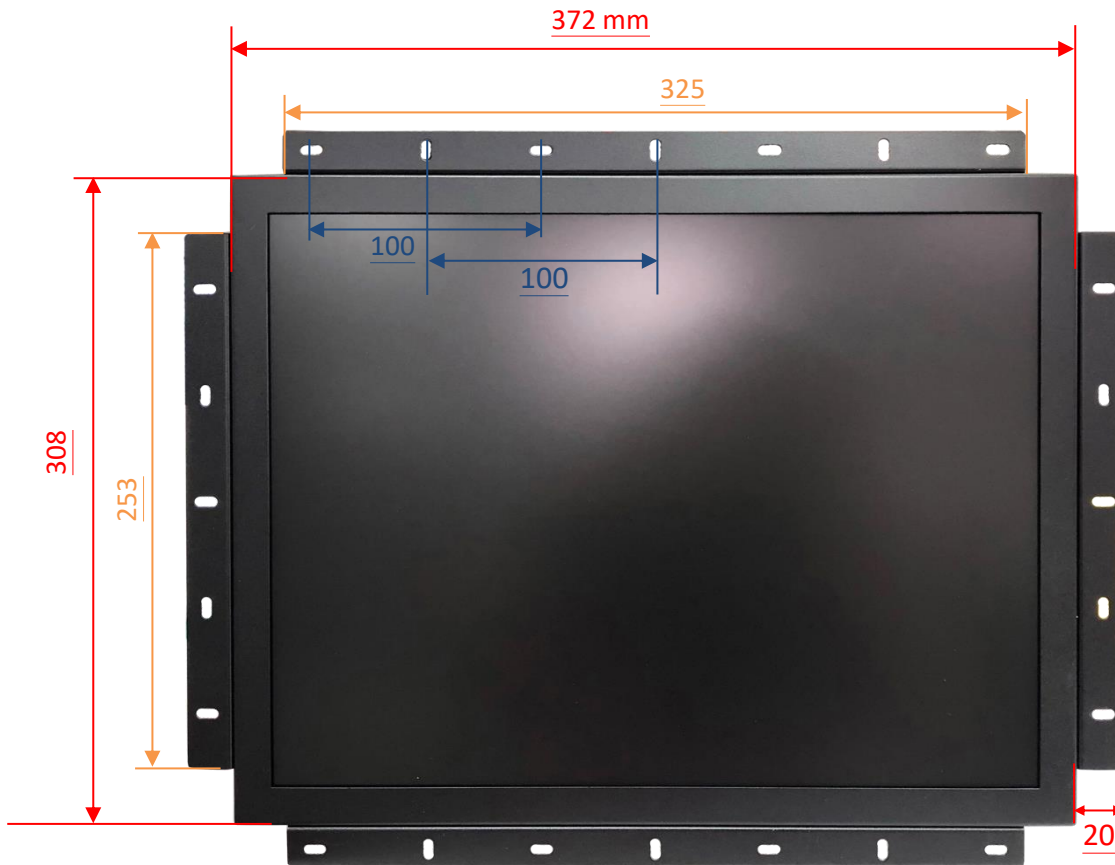
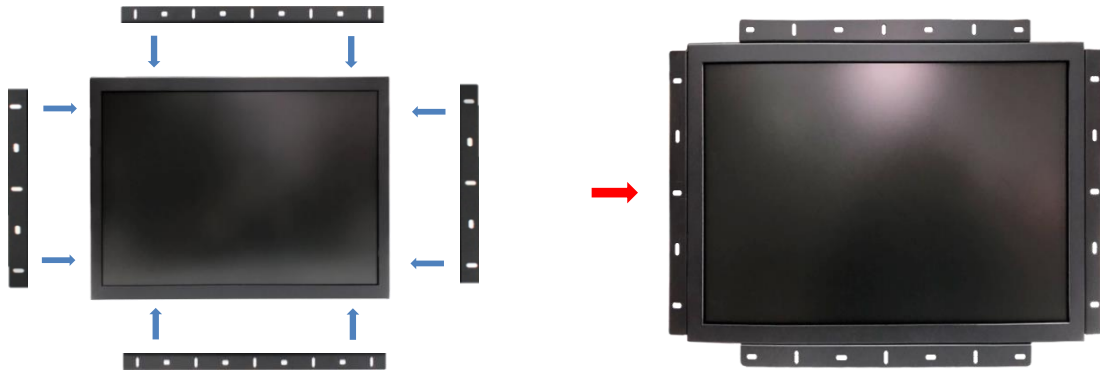
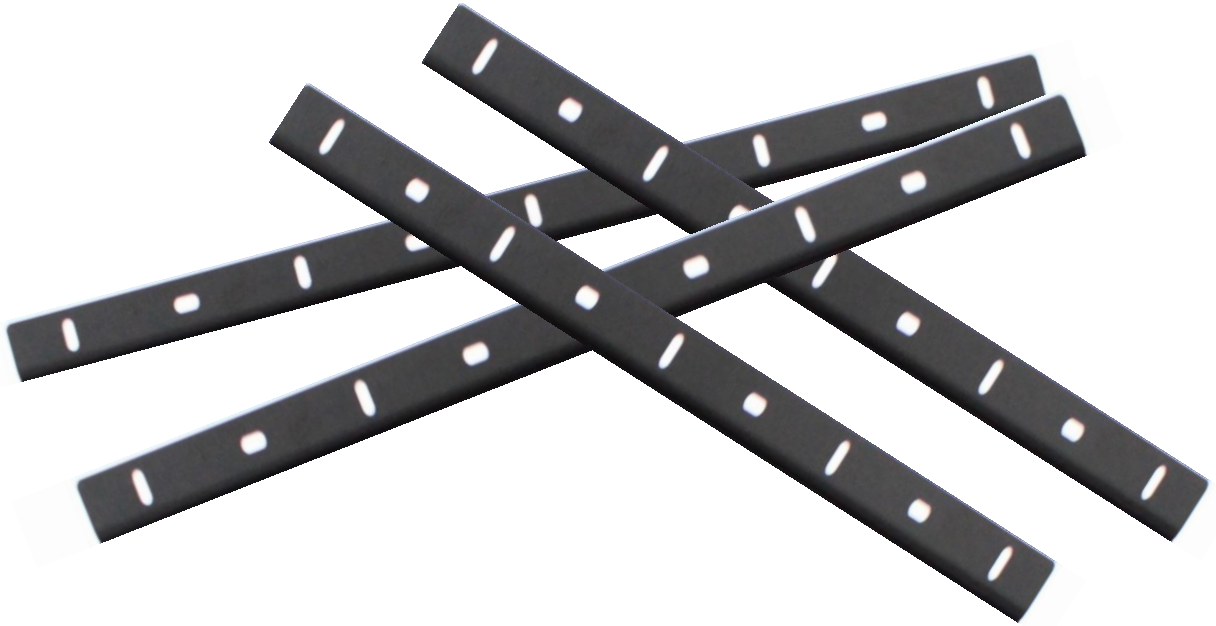

Optional Accessories (Panel Mount Kits)

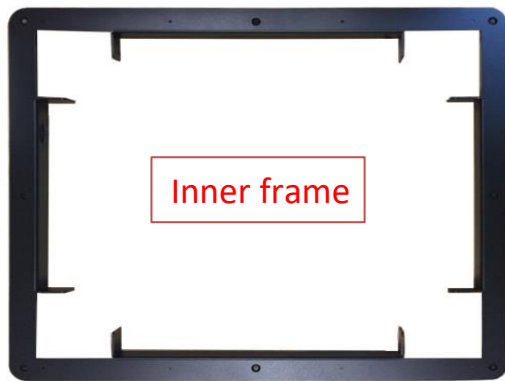
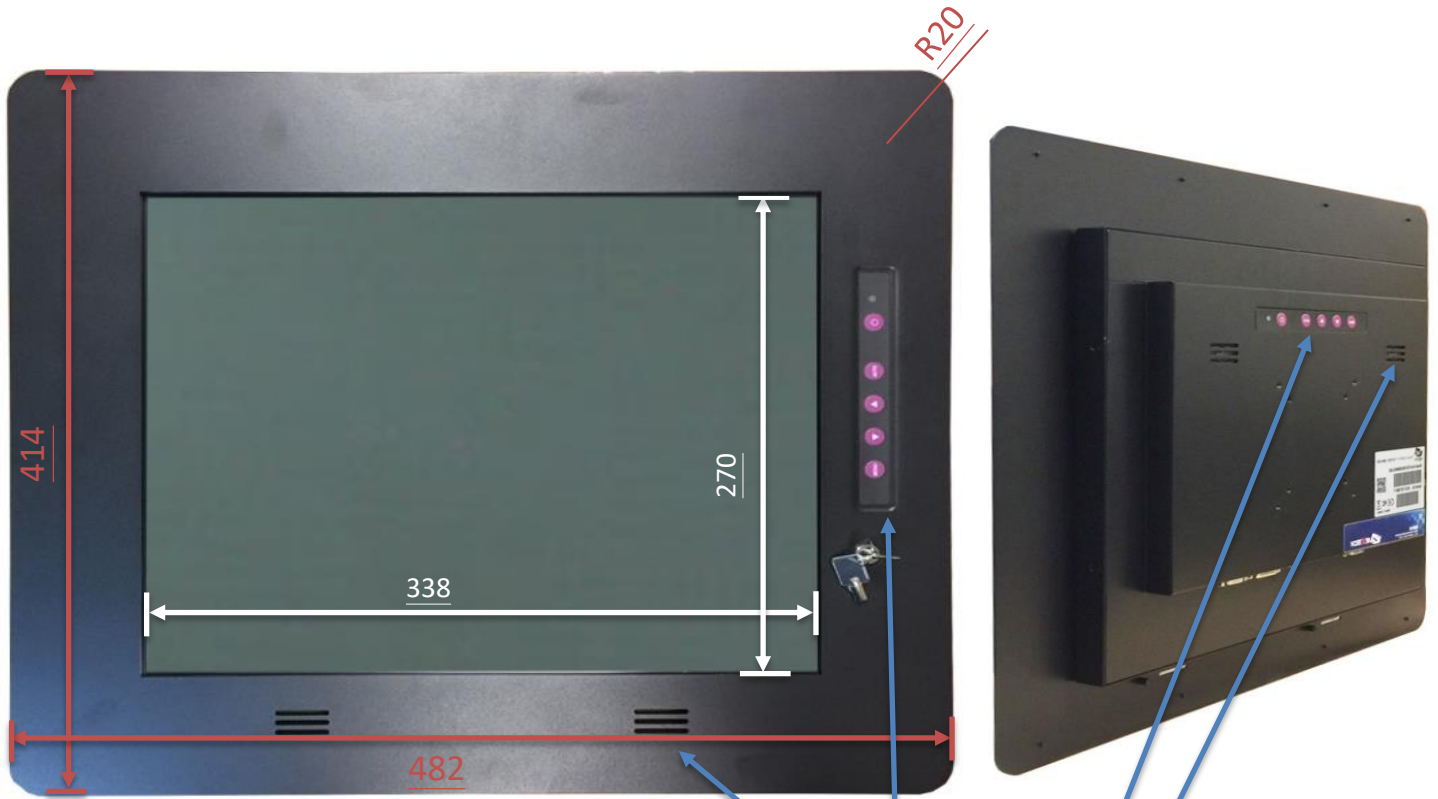

Tips.  
OSD button and speaker can be on front or hidden on back.

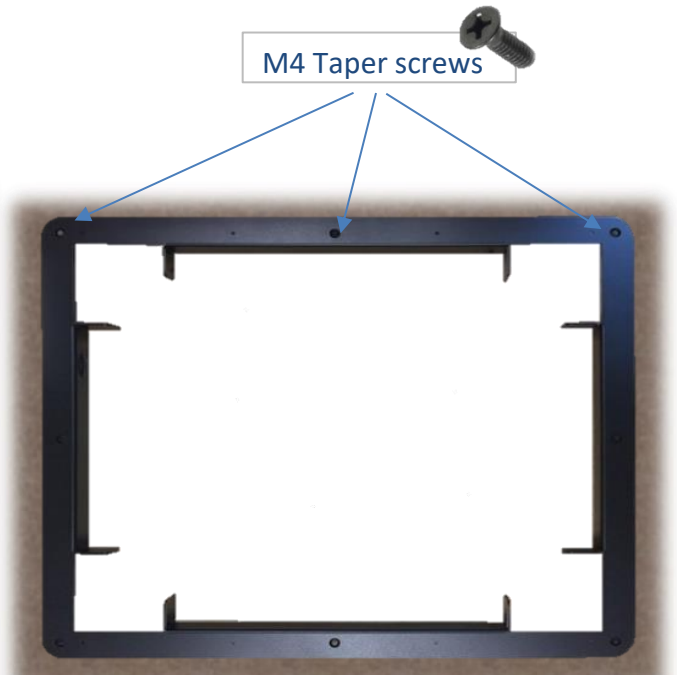
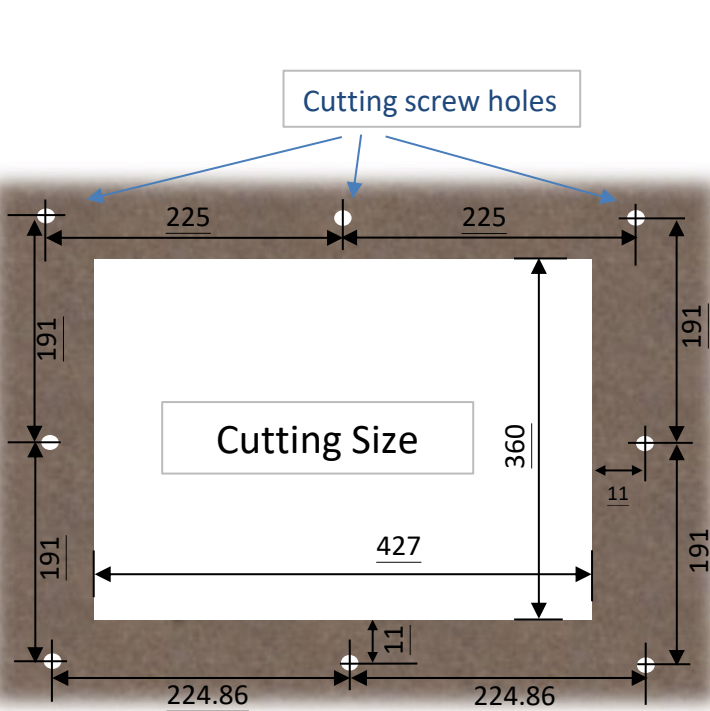

Optional Accessories (Panel Mount Kits)

Installing Guide

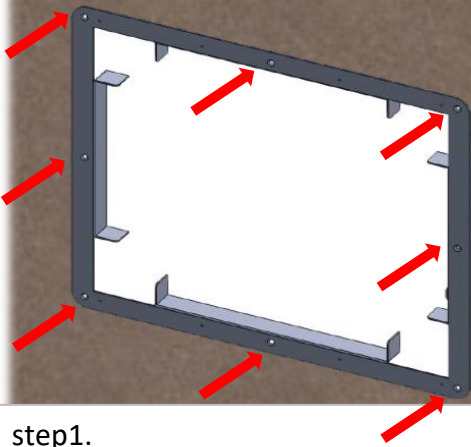

step1.  
Mount the inner frame to wall/door/KIOSK , and screw it.  
(Use M4 taper screws )

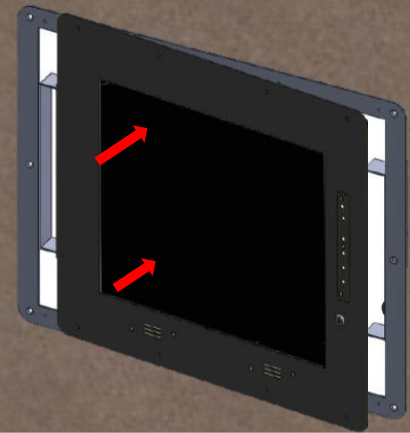

step2.  
Mount the display from front and slightly keep right (insert aslant)

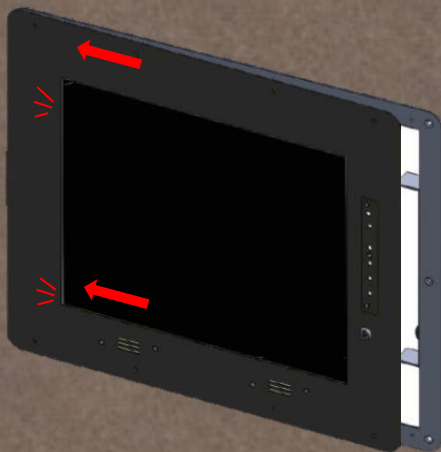

step3.  
Push the display to the left, stuck up.



step4.  
Push the display to insert completely



step5.  
Lock it !



**Optional Accessories (Wall Mount Bracket)**

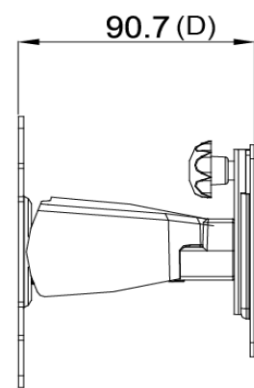
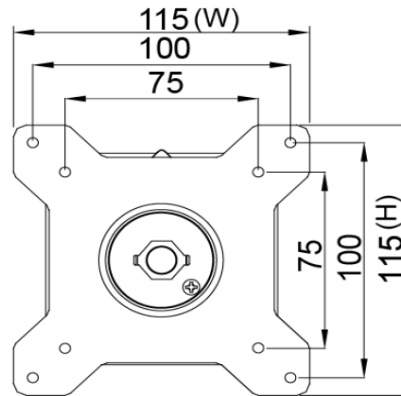
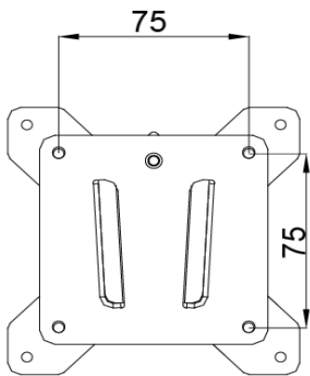

**Packing Information**

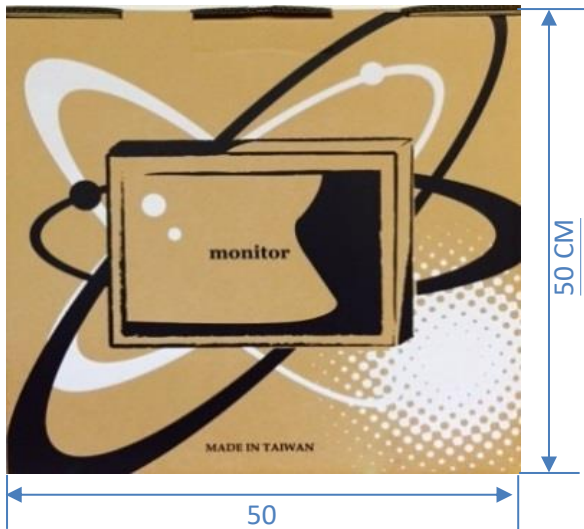

Net Weight	≤ 3.72 KG
Gross Weight	≤ 5.4 KG
Q'ty per Pallet	
Pallet Size	
Total Size	

## Optional Accessories (Desktop Stand or Arm)



- 273x180x265 mm
- 1.07 KG
- Support 12 KG



- 620x556x123 mm
- 3 KG
- Support 10 KG



- 250x192x445 mm
- 1.4 KG
- Support 12 KG



- 655x858.5x563 mm
- 7.56 KG
- Support 30 KG



- 158x403x144 mm
- 2.12 KG
- Support 12 KG

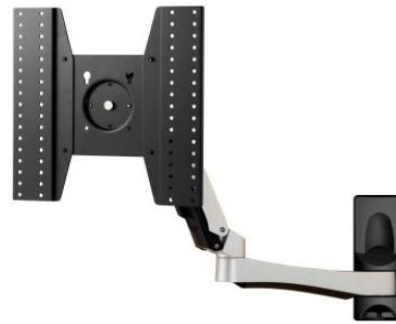

- 646x861x953.5 mm
- 8.57 KG
- Support 30 KG



- 423x403x240 mm
- 1.91 KG
- Support 12 KG



- 1300x403x307 mm
- 5.3 KG
- Support 8 KG



- 715x393x144 mm
- 3.68 KG
- Support 12 KG

