



# Product Specifications





Customer :	
Model No. :	NTM121



**Features :**

- ★ 12.1" 1024x768(XGA 4:3) Resolution
- ★ Wide Operating Temperature (-30~70°C)
- ★ Resistive/Capacitive Touch Options
- ★ Metal Cabinet with Diverse Installing Options
- ★ Made in Taiwan, 3 Years Warranty
- ★ Designed for All Environments
- ★ High Brightness Options
- ★ AG/AR/AF Film Options



			
BSMI	CE	FCC	RoHS
<b>Compliance</b>			

Records of Revision			
Vision	Modifying	Old Description	New Description
v1708.1	Revision		



## General Specifications

### Display Specifications

Model No.	NTM121XXXXXX *	Pixel Pitch	0.24x0.24 mm
Screen Diagonal	12.1 inch	Response Time	11 msec
Display Area	245.76x184.32 mm	Backlight Unit	LED (white LED)
Resolution	1024x768 (XGA)	Viewing Angle (L/R,U/D)	160°/140° (CR≥10)
Brightness	500 nits (options)	Backlight Life Time	30000 HRS
Contrast Ratio	700:1	Operating Temp.	-30-70°C
Display Ratio	4:3	Surface Treatment	Anti-glare, Hardness 3H
Support Color	16.2M Color		

\* Depends on specifications and options

### Brightness Options

Item	Brightness	Model No.
Standard	500 nits	NTM121XXXXNXX
Enhanced *	1000 nits	NTM121XXXXAXX
Enhanced *	1500 nits	NTM121XXXXFXX

\* For outdoor application

### Display Input

Item	Connectors
Standard	VGA+DVI

### Power Input/Audio Input

Item	Description	Connector
Power Input	DC-12V, with AC/DC Adapter 100~240V	DC Jack Φ2.1mm
Audio Input	Stereo	TRS connector 3.5mm

### Physical Specifications

Dimension (Max)	270x212.9x39.9 mm	Cabinet Material	Galvanized steel (SECC)
Speaker	2W x2	Net Weight	≤2.5 KG
Wall Mount Hole	75x75 mm	Gross Weight	≤3.5 KG

### Cabinet Options

Item	Description
Standard	Galvanized steel (SECC)
Option	Stainless Steel
Option	Aluminum

### Surface Film Options

AG	Anti-Glare	AR	Anti-Reflective
AFP	Anti-Fouling/Fingerprint	AS	Anti-Spy

### Touch Specifications

#### Non-touch Model

Model No.	NTM1210XXXXXX		
-----------	---------------	--	--

#### Resistive Touch Model

Model No.	NTM1215XXXXXX	Transparency	80% ±5%
Touch Screen	5 Wire Resistive Touch	Precision	98.50%
Allowed touch points	1 point	Surface Treatment	Anti-glare <15%
Interface	USB/RS232	Hardness	≥3H

#### Projected Capacitive Touch Model

Model No.	NTM121YXXXXXX	Transparency	≥90% ±3%
Touch Screen	Projected Capacitive	Accuracy	99.00%
Allowed touch points	10 points	Surface Treatment	Tempered
Interface	USB	Hardness	≥7H

#### Surface Capacitive Touch Model

Full Model No.	NTM121CXXXXXX	Transparency	≥92% ±3%
Touch Screen	Surface Capacitive	Precision	99.00%
Allowed touch points	1 point	Surface Treatment	Anti-glare <7%
Interface	USB/RS232	Hardness	≥9H

### Accessories

Item	Description	Quantity
VGA Cable	D-Sub 15Pin Male to Male , 1.2 Meter	1
Audio cable	3.5mm Headset Jack , Male to Male , 1.2 Meter	1
AC-DC Adapter	4.16A/12V with CE/FCC/CCC/UL/RoHS/PSE/JET Certification	1
Power cord	*(depends on Country)	1
USB Cable	A type , Male to Male , 1.5 Meter *(only for touch models)	1



**Outward and Dimensions**

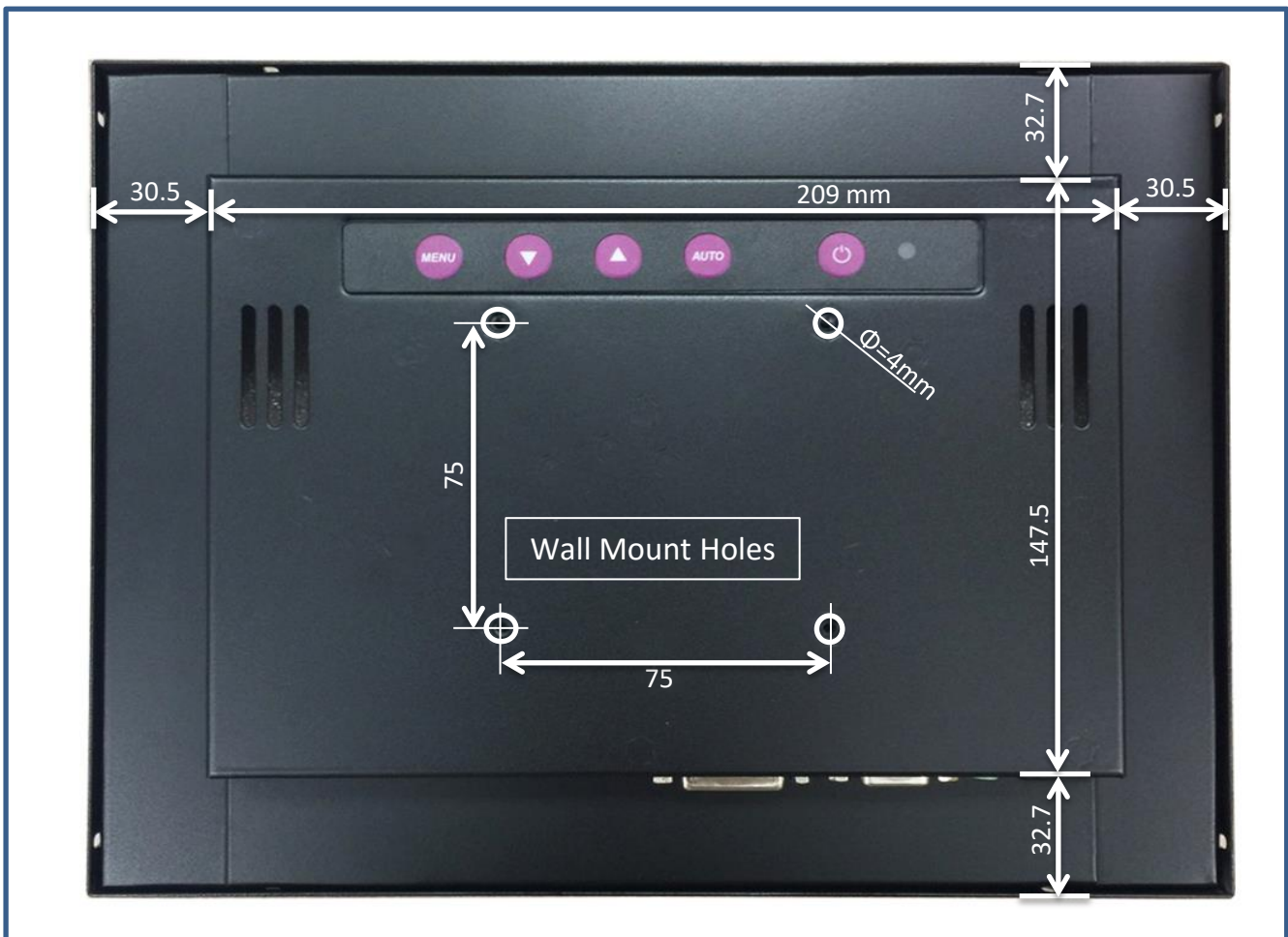
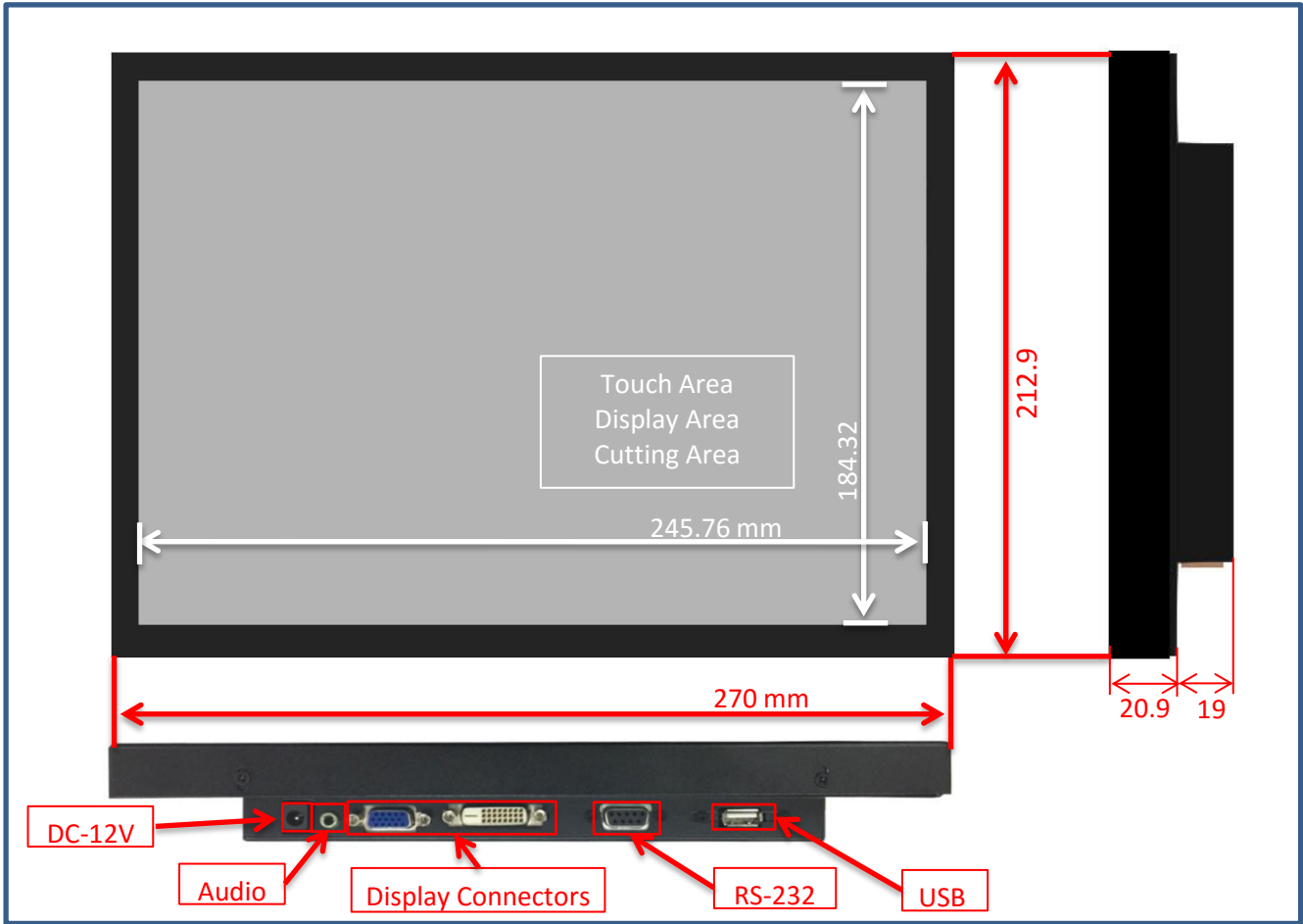

**Optional Accessories (Desktop Stand)**

Item	B Stand	Part No.	P1SS0 / P1SS0-02
Mounting Pattern	100x100 / 75x75 mm	Dimension (WxHxD)	203x275x227 mm
Material	Steel/Plastic/Aluminum	Net Weight	1.8 KG
Tilt(Hinge)	-2° ~ +180°	Support Max. Weight	15 KG

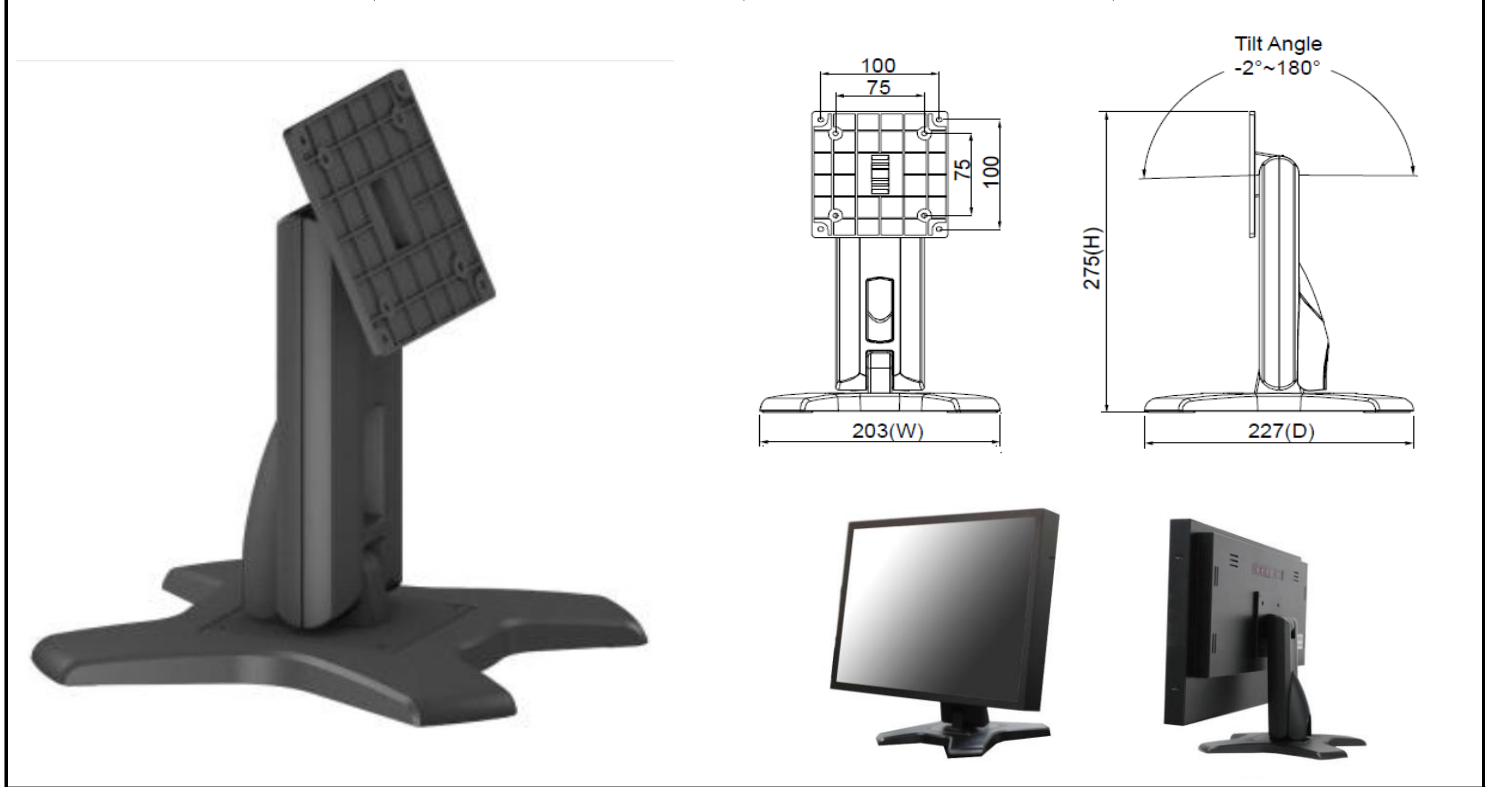

Item	Z Stand	Part No.	P1SZ2
Mounting Pattern	100x100 / 75x75 mm	Dimension (WxHxD)	190x240x41.6
Material	SECC	Net Weight	2.6 KG
Tilt(Hinge)	±360°	Support Max. Weight	15 KG

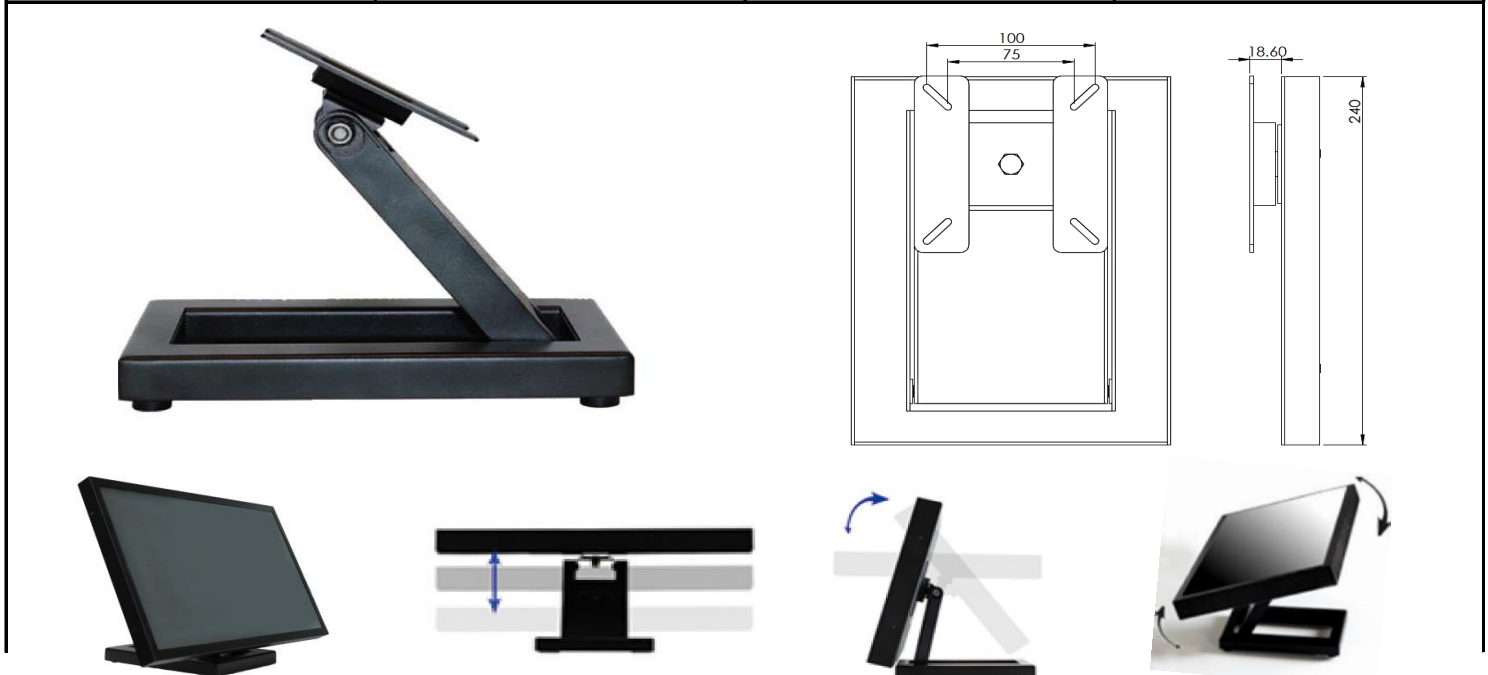

### Optional Accessories (Open-frame Brackets)

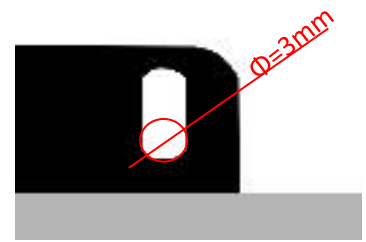
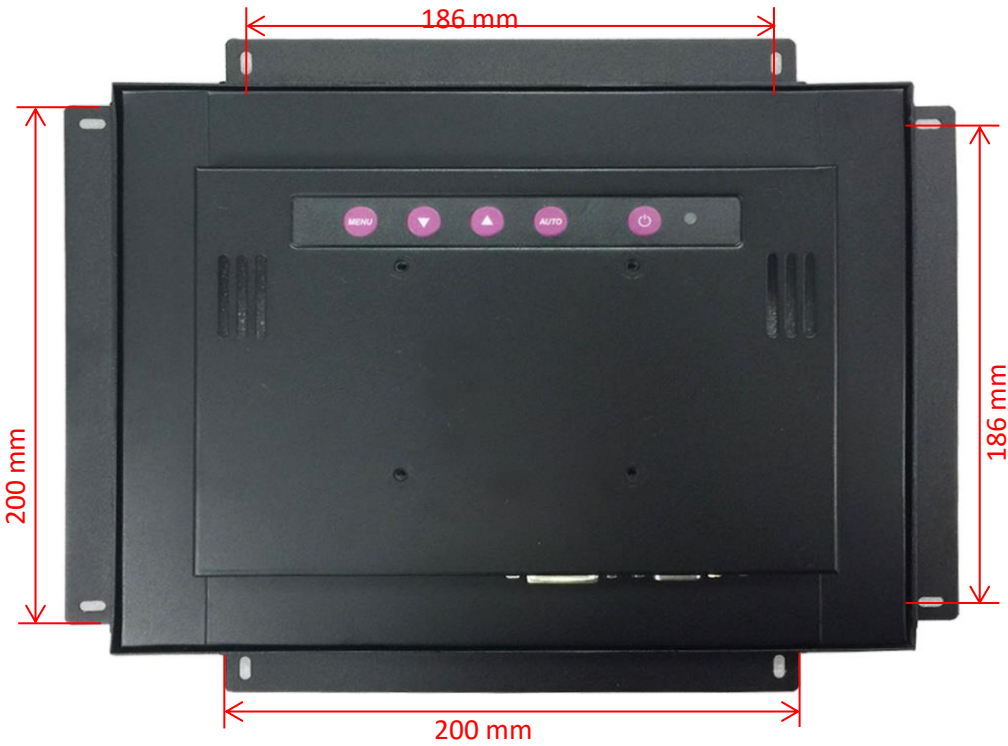
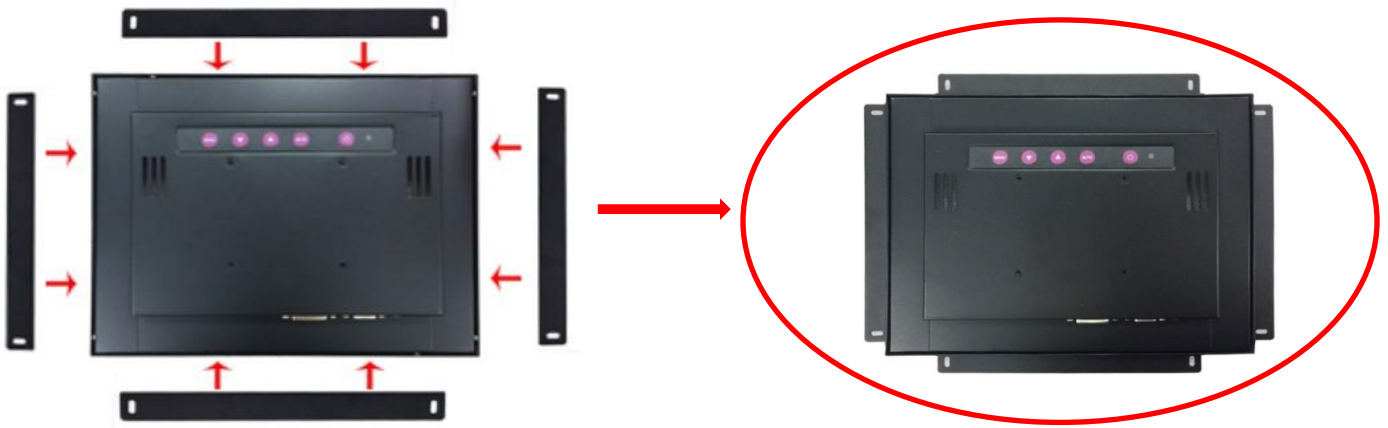

**Optional Accessories (Wall Mount Bracket)**

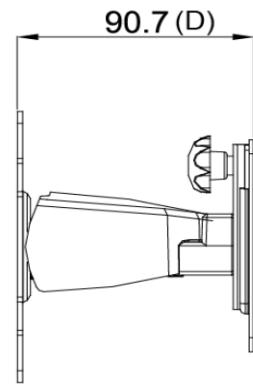
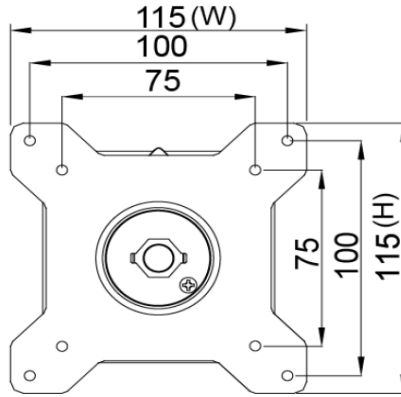
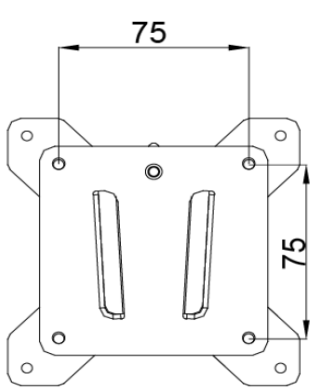

**Packing Information**



Net Weight	≤ 2.5 KG
Gross Weight	≤ 3.5 KG
Q'ty per Pallet	135 unit
Pallet Size	120x100x15 CM
Total Size	120x100x150 CM

**Optional Accessories (Desktop Stand or Arm)**



- 273x180x265 mm  
 - 1.07 KG  
 - Support 12 KG



- 620x556x123 mm  
 - 3 KG  
 - Support 10 KG



- 250x192x445 mm  
 - 1.4 KG  
 - Support 12 KG



- 655x858.5x563 mm  
 - 7.56 KG  
 - Support 30 KG



- 158x403x144 mm  
 - 2.12 KG  
 - Support 12 KG

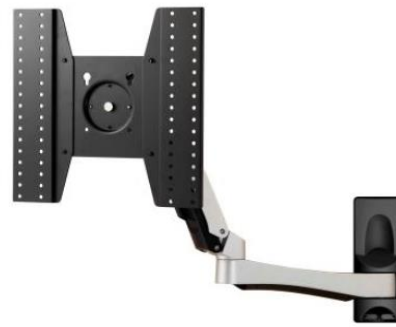

- 646x861x953.5 mm  
 - 8.57 KG  
 - Support 30 KG



- 423x403x240 mm  
 - 1.91 KG  
 - Support 12 KG



- 1300x403x307 mm  
 - 5.3 KG  
 - Support 8 KG



- 715x393x144 mm  
 - 3.68 KG  
 - Support 12 KG

