



# Product Specifications

Customer :	
Model No. :	NTM150 V022



**Features :**

- ★ 15" 1024x768 (XGA 4:3) Resolution
- ★ IPS Technology, Wide Viewing Angle (176°/176°)
- ★ Wide Operating Temperature (-30~80°C)
- ★ Resistive/SCAP/PCAP Touch Options
- ★ Metal Cabinet with Diverse Installing Options
- ★ Made in Taiwan, 3 Years Warranty
- ★ Designed for all Environments
- ★ High Brightness Options
- ★ Anti-Glare/Reflection/Fingerprint/SPY... Options
- ★ All Kind of Connector Options (VGA/DVI/HDMI/DP)



			
BSMI	CE	FCC	RoHS
<b>Compliance</b>			

Records of Revision			
Vision	Modifying	Old Description	New Description
v1703.1	First Version		
v1703.2	Revising of the Display Area	307.4x231.3	304.1x228.1
v1708.1	Revision		

### General Specifications

#### Display Specifications

Full Model No.	NTM150XXXXXXXX-022 *	Pixel Pitch	0.297x0.297 mm
Screen Diagonal	15.0 inch	Response Time	18 msec
Display Area	304.1x228.1	Backlight Unit	LED (white LED)
Resolution	1024x768 (XGA)	Viewing Angle (L/R,U/D)	176° / 176° (IPS)
Brightness	500 nits (options)	Backlight Life Time	70000 HRS
Contrast Ratio	2500:1	Operating Temp.	-30~80°C
Display Ratio	4:3	Surface Treatment	Anti-glare, Hardness 3H
Support Color	16.7M Color		

\* Depends on specifications and options.

#### Brightness Options

Item	Brightness	Model No.
Standard	500 nits	NTM150XXXXX5XX-022
Enhanced *	1000 nits	NTM150XXXXXAXX-022
Enhanced *	1600 nits	NTM150XXXXXGXX-022

\* For outdoor application.

#### Display Input Options

Item	Connectors	Model No.
Standard	VGA+DVI	NTM150XXXXXXXXD-022
Option	VGA+DVI+HDMI	NTM150XXXXXXXX7-022
Option	VGA+HDMI+DP	NTM150XXXXXXXX3-022

#### Power Input Options

Item	Description	Connector
DC 12V (Standard)	DC-12V, with AC/DC Adapter 100~240V	DC Jack Φ2.1mm
DC 12V (Lockable)	DC-12V, with AC/DC Adapter 100~240V	DC Jack Φ2.1mm Lockable

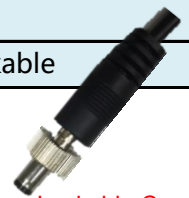

Lockable Connector

#### Audio Input

Item	Description	Connector
Audio Input	Stereo	TRS connector 3.5mm



Audio Input

**Physical Specifications**

Dimension (Max)	333x260.7x47 mm	Cabinet Material	Galvanized steel (SECC)
Speaker	2W x2	Net Weight	≤ 3 KG
Wall Mount Hole	75x75 / 100x100 mm	Gross Weight	≤ 4 KG

**Cabinet Options**

Item	Description
Standard	Galvanized steel (SECC)
Option	Stainless Steel
Option	Aluminum

**Fan Options**

Item	Description
Fanless	Fanless
Built-in (option)*	7 Blades/1.2W/4000r.p.m/Max.10.96CFM/28.3dB

\* Fan use the space of speakers, fan and speakers can't both exist in one model

**Surface Film Options**

AG	Anti-Glare	AR	Anti-Reflective
AFP	Anti-Fouling/Fingerprint	AS	Anti-Spy

**Display Control Options**

Item	Description
OSD	Physical button (standard)
Software	Software Control via RS232 interface.



OSD Button



Software Control via RS232 interface.

**Accessories**

Item	Description	Quantity
VGA Cable	D-Sub 15Pin Male to Male , 1.2 Meter	1
Audio cable	3.5mm Headset Jack , Male to Male , 1.2 Meter	1
AC-DC Adapter	4.16A/12V with CE/FCC/CCC/UL/RoHS/PSE/JET Certification	1
Power cord	*(depends on Country)	1
USB Cable	A type , Male to Male , 1.5 Meter *(only for touch models)	1



**Touch Specifications****Non-touch Model**

Full Model No.	NTM1500XXXXX		
----------------	--------------	--	--

**Resistive Touch Model**

Full Model No.	NTM1505XXXXX	Transparency	80% ±5%
Touch Screen	5 Wire Resistive Touch	Accuracy	98.50%
Allowed touch points	1 point	Surface Treatment	Anti-glare <15%
Interface	USB/RS232	Hardness	≥3H

**Projected Capacitive Touch Model**

Full Model No.	NTM150YXXXXX	Transparency	≥90% ±3%
Touch Screen	Projected Capacitive	Accuracy	99.00%
Allowed touch points	10 points	Surface Treatment	Tempered
Interface	USB	Hardness	≥7H

**Surface Capacitive Touch Model**

Full Model No.	NTM150CXXXXX	Transparency	≥92% ±3%
Touch Screen	Surface Capacitive	Accuracy	99.00%
Allowed touch points	1 point	Surface Treatment	Anti-glare <7%
Interface	USB/RS232	Hardness	≥9H

**Outward and Dimensions**

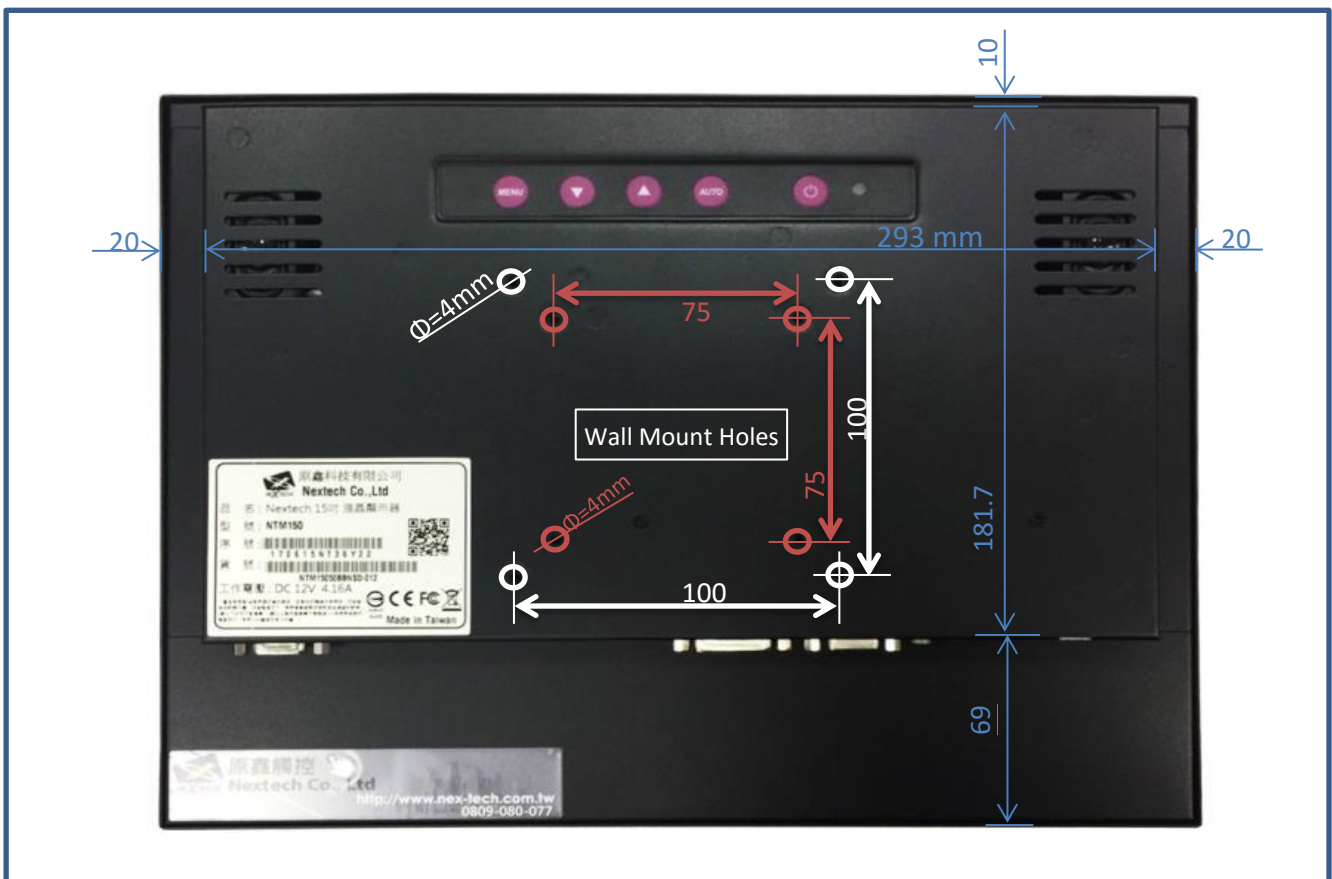
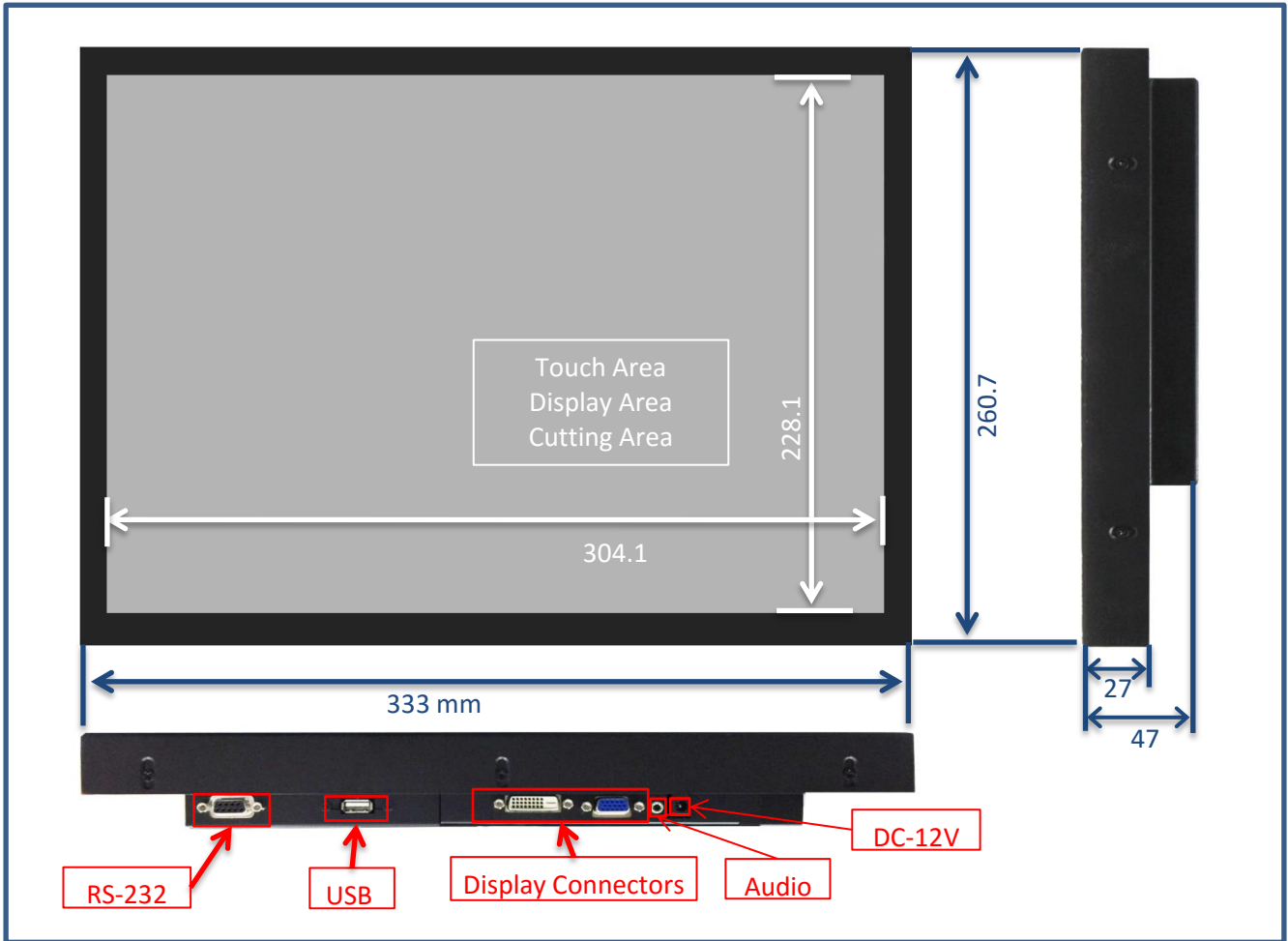

**Optional Accessories (Desktop Stand)**

Item	B Stand	Part No.	P1SS0 / P1SS0-02
Mounting Pattern	100x100 / 75x75 mm	Dimension (WxHxD)	203x275x227 mm
Material	Steel/Plastic/Aluminum	Net Weight	1.8 KG
Tilt(Hinge)	-2° ~ +180°	Support Max. Weight	15 KG

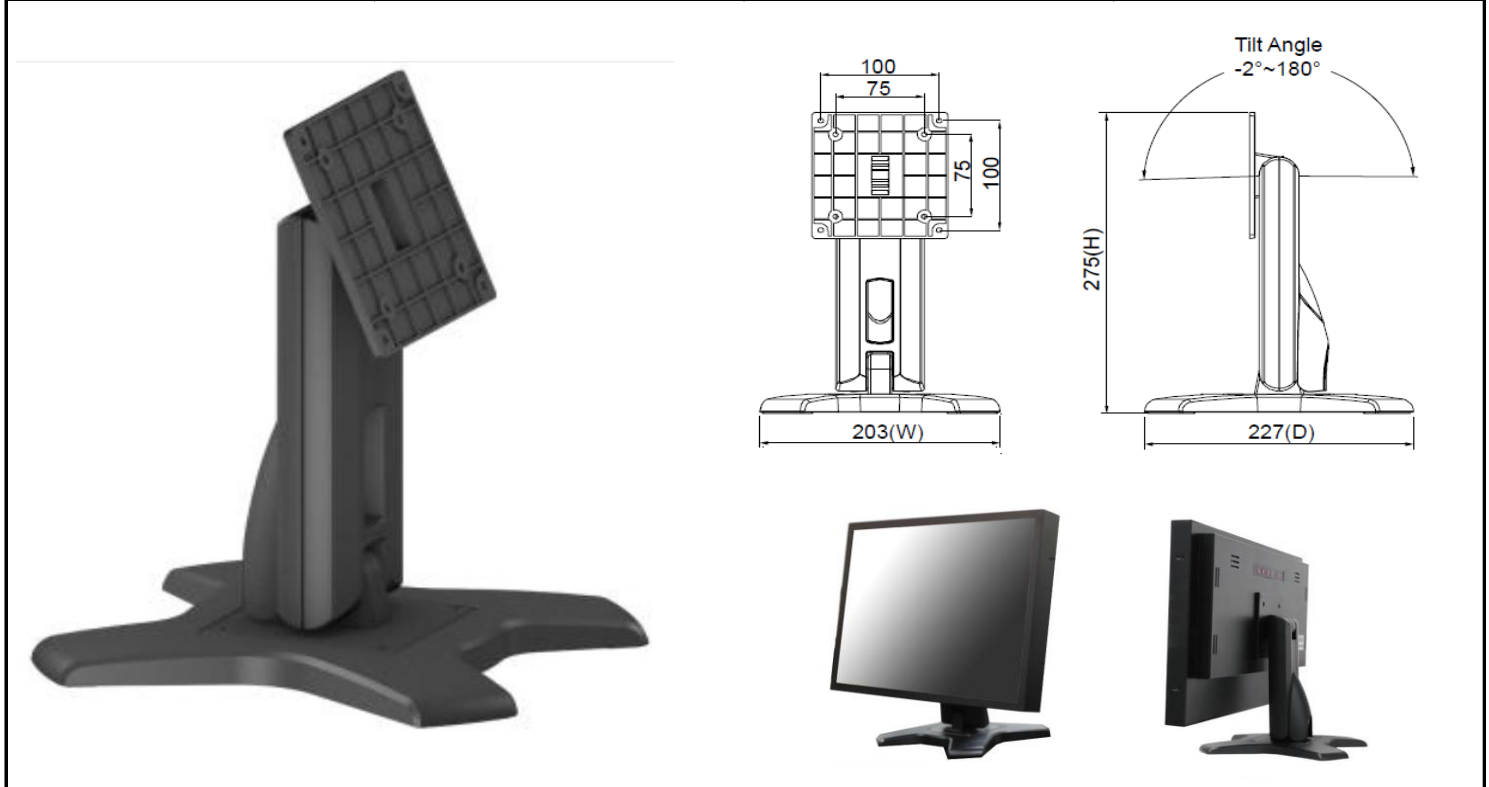

Item	Z Stand	Part No.	P1SZ2
Mounting Pattern	100x100 / 75x75 mm	Dimension (WxHxD)	190x240x41.6
Material	SECC	Net Weight	2.6 KG
Tilt(Hinge)	±360°	Support Max. Weight	15 KG

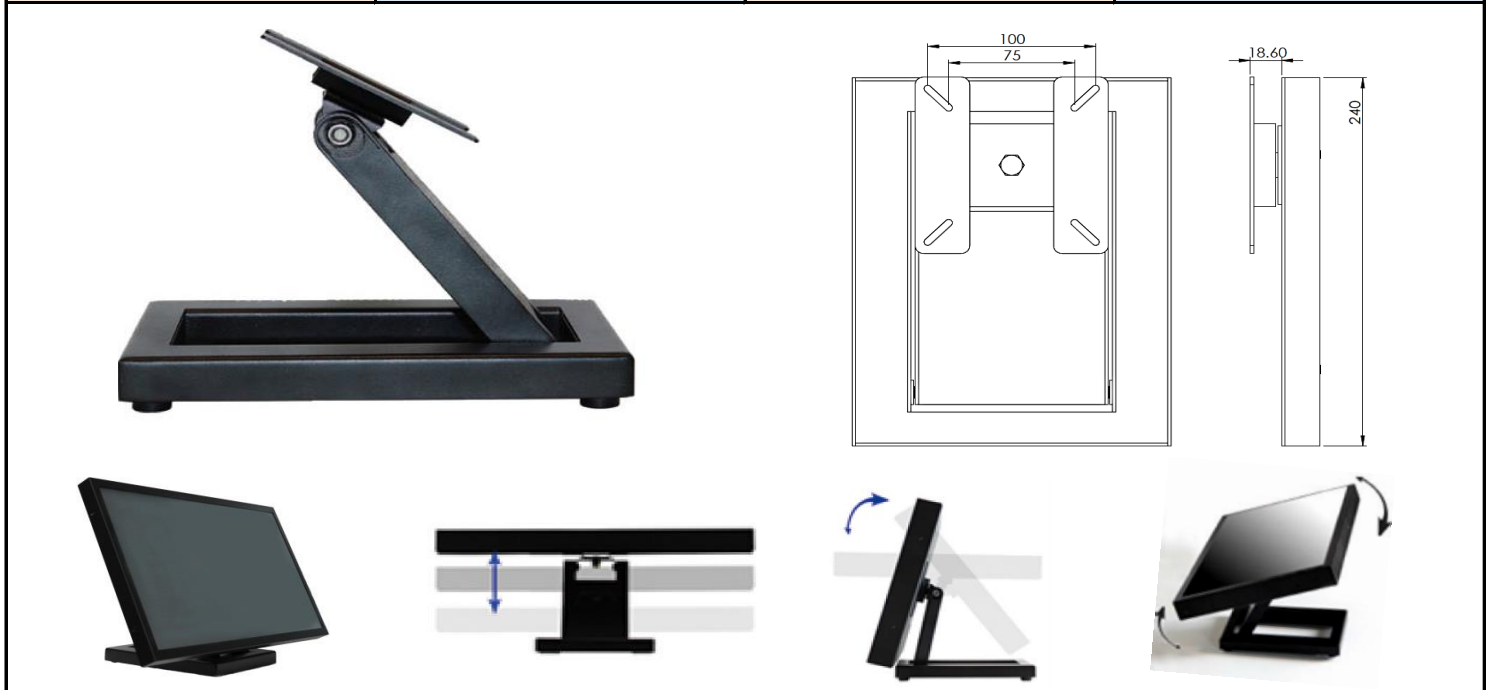

Optional Accessories (Open-frame Brackets)

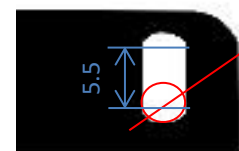
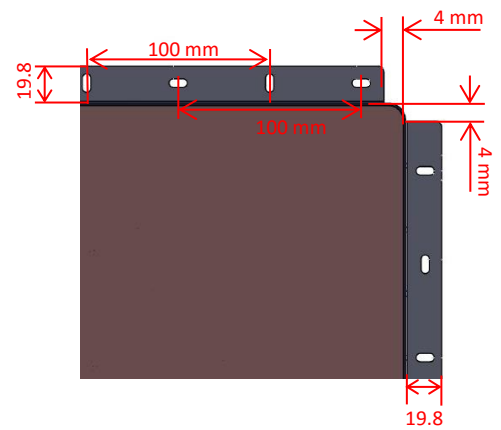
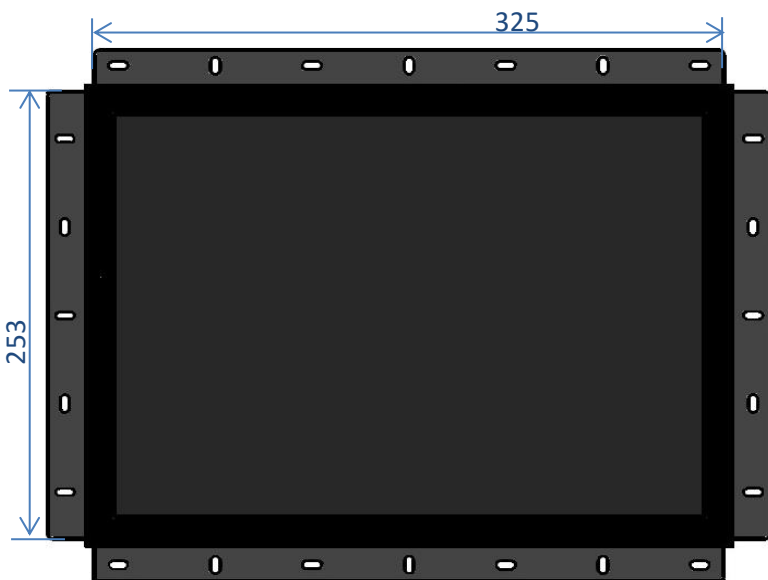
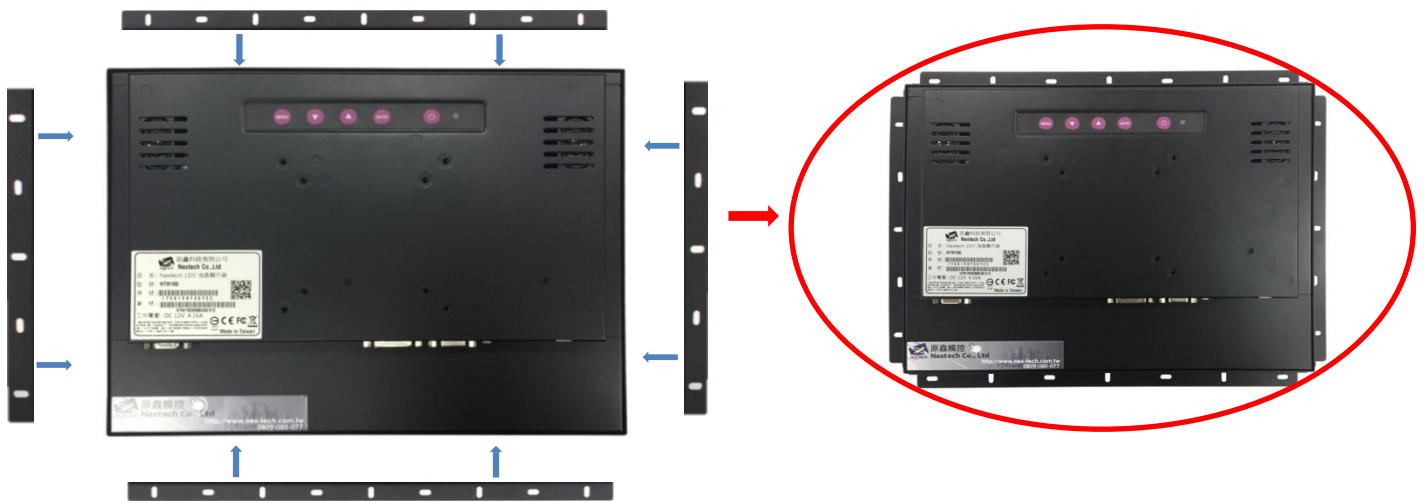
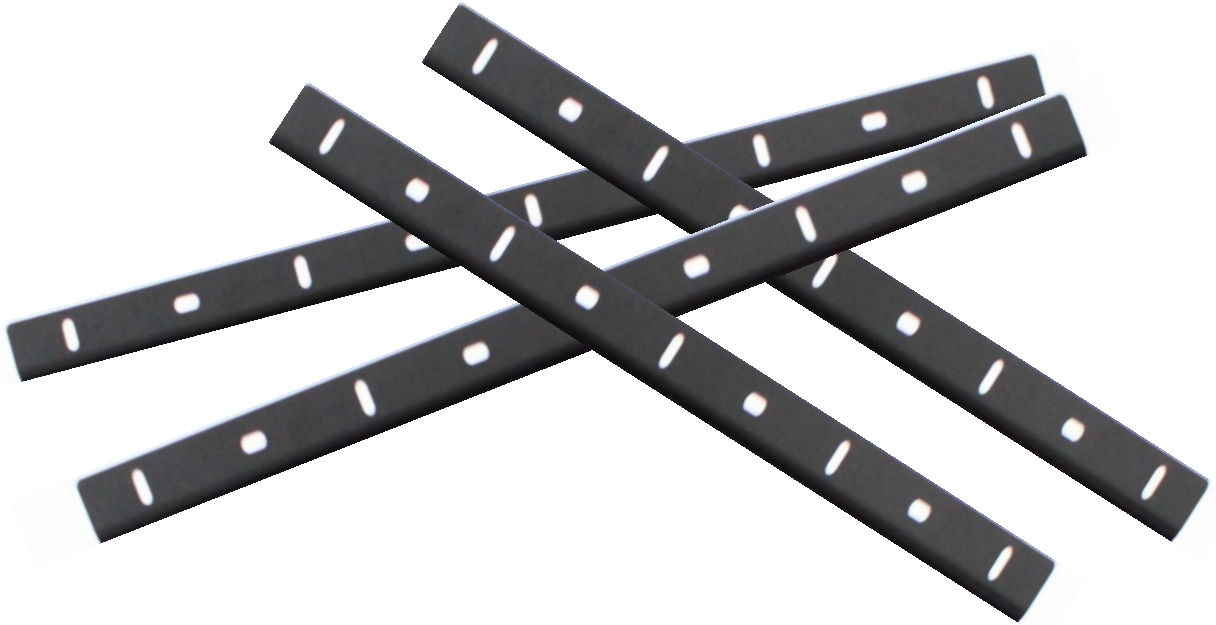

Optional Accessories (Panel Mount Kits)

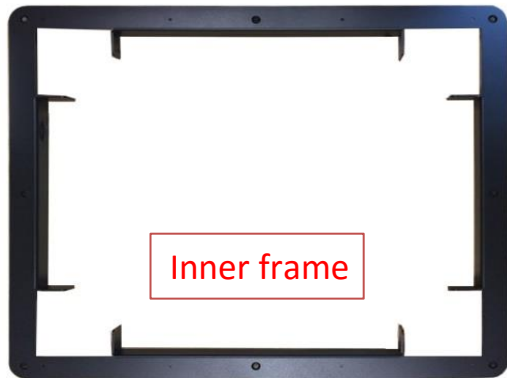
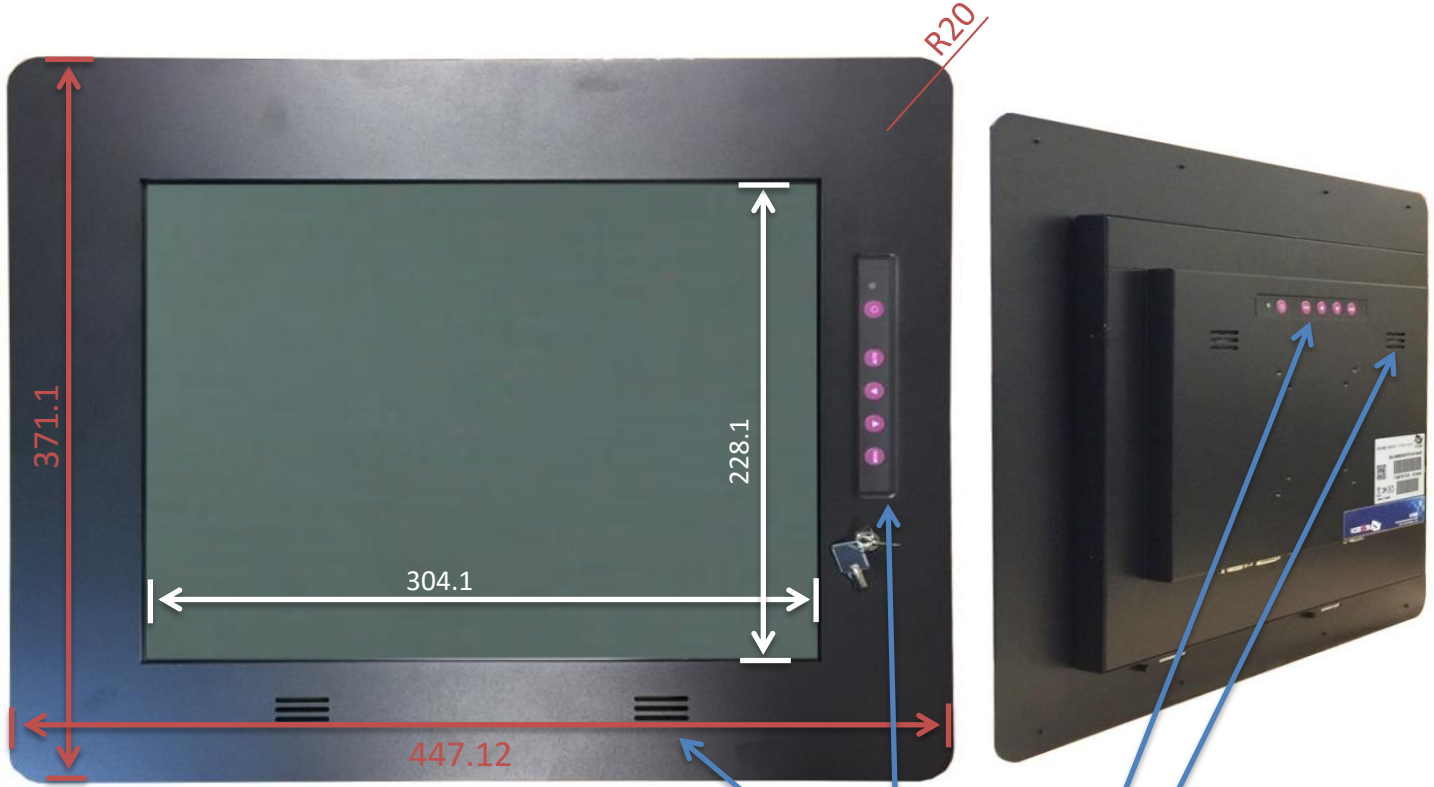

Tips.  
OSD button and speaker can be on front or hidden on back.

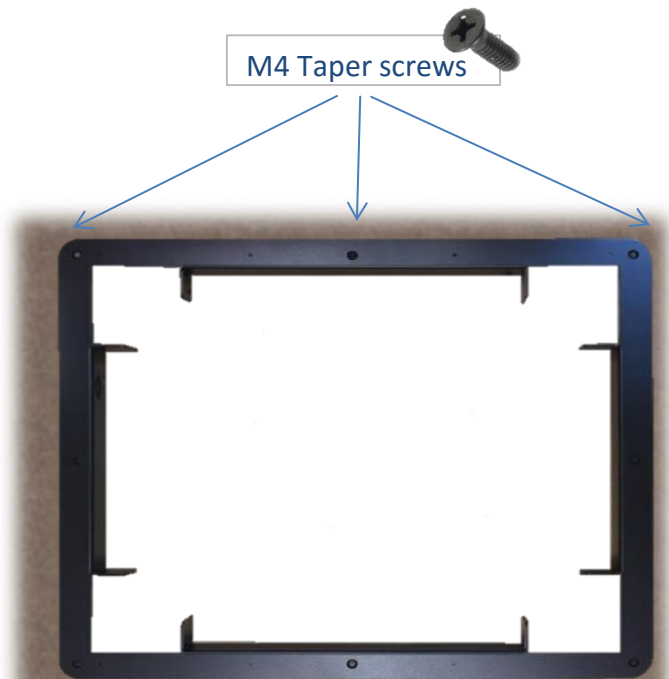
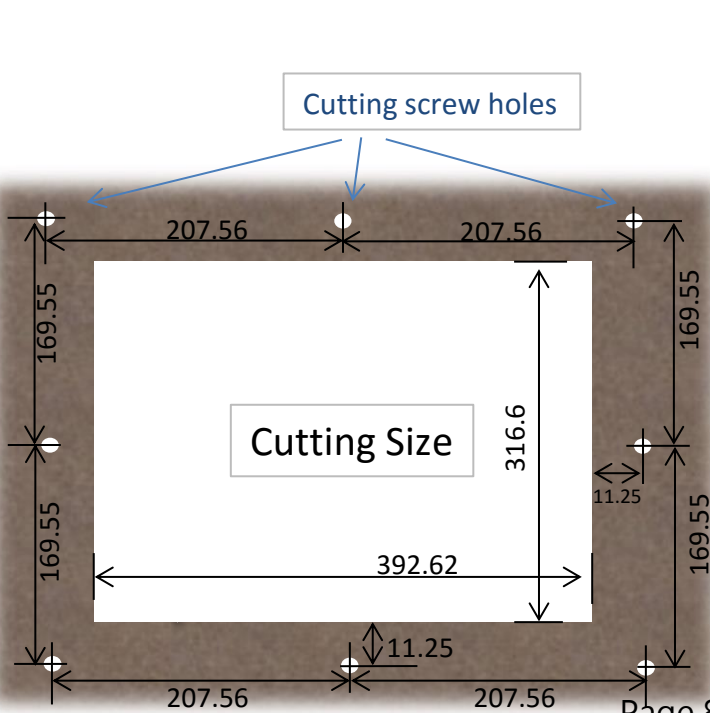

## Optional Accessories (Panel Mount Kits)

## Installing Guide

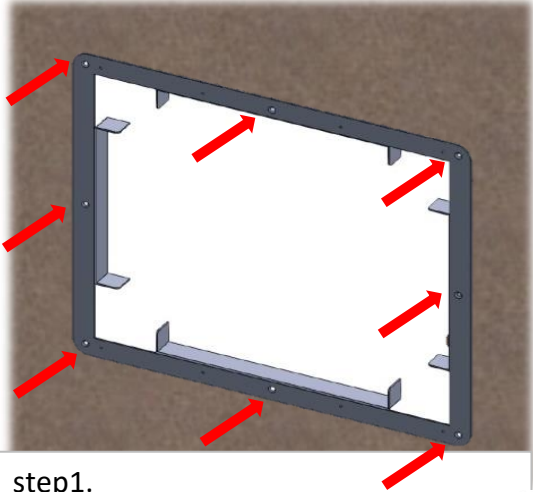

step1.  
Mount the inner frame to wall/door/KIOSK , and screw it.  
(Use M4 taper screws )

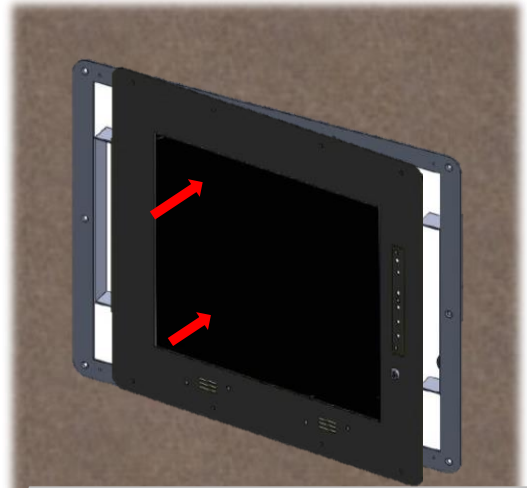

step2.  
Mount the display from front and slightly keep right (insert aslant)

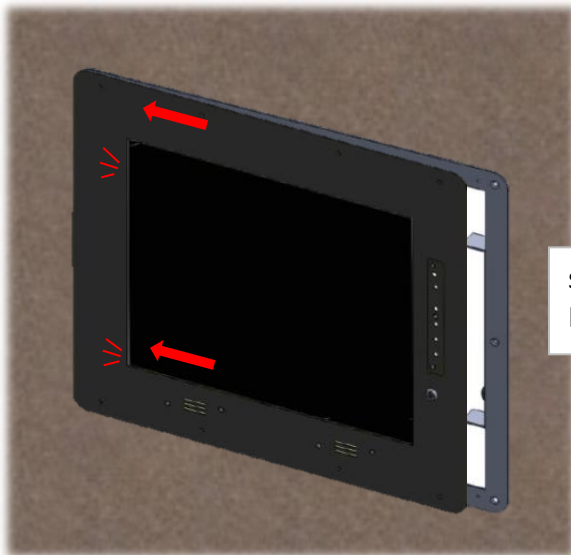

step3.  
Push the display to the left, stuck up.

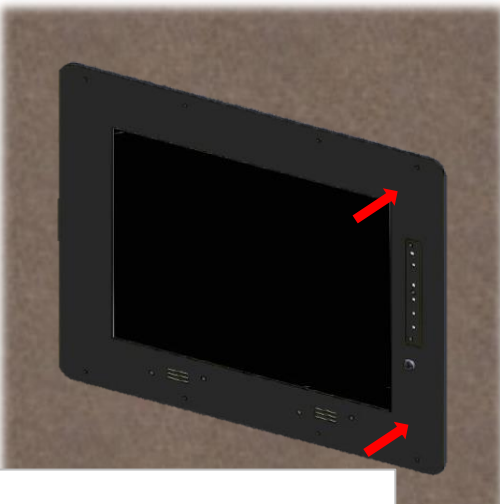

step4.  
Push the display to insert completely



step5.  
Lock it !



**Optional Accessories (Wall Mount Bracket)**

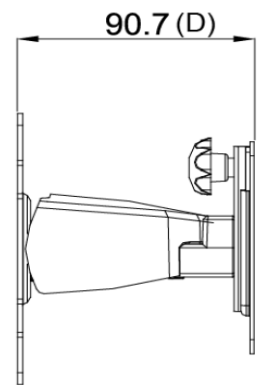
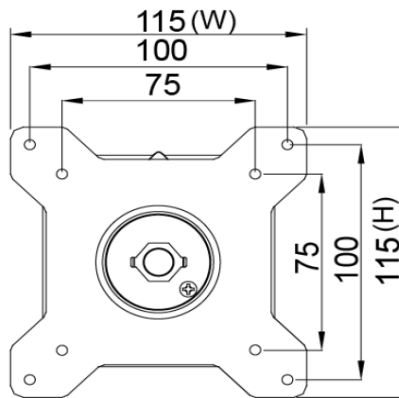
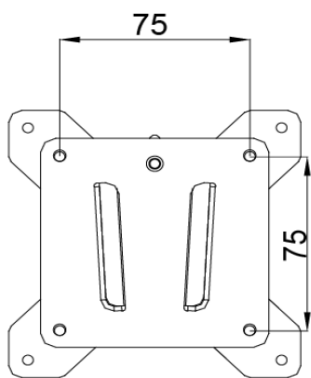

**Packing Information**

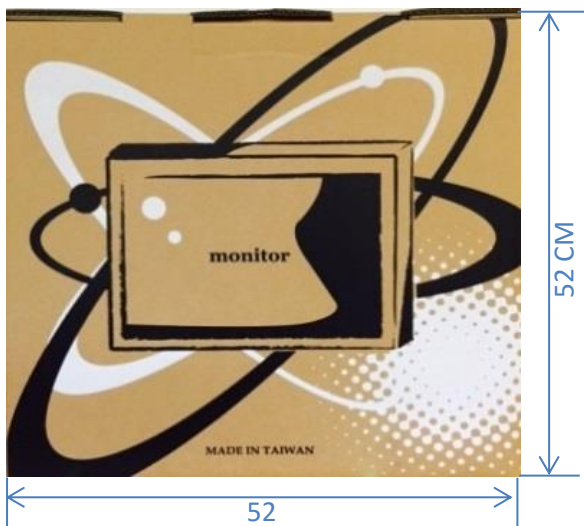

Net Weight	3KG
Gross Weight	4KG
Q'ty per Pallet	20
Pallet Size	120x100x15 CM
Total Size	120x100x119 CM

**Optional Accessories (Desktop Stand or Arm)**



- 273x180x265 mm  
 - 1.07 KG  
 - Support 12 KG



- 620x556x123 mm  
 - 3 KG  
 - Support 10 KG



- 250x192x445 mm  
 - 1.4 KG  
 - Support 12 KG



- 655x858.5x563 mm  
 - 7.56 KG  
 - Support 30 KG



- 158x403x144 mm  
 - 2.12 KG  
 - Support 12 KG



- 646x861x953.5 mm  
 - 8.57 KG  
 - Support 30 KG



- 423x403x240 mm  
 - 1.91 KG  
 - Support 12 KG



- 1300x403x307 mm  
 - 5.3 KG  
 - Support 8 KG



- 715x393x144 mm  
 - 3.68 KG  
 - Support 12 KG

