



Product Specifications





Customer :	
Model No. :	NTSP104



Features :

- ★ 10.4" 800x600(SVGA 4:3) Resolution
- ★ Wide Operating Temperature (-20~70°C)
- ★ Projected Capacitive Touch Option
- ★ 7H Hardness Tempered Cover Glass
- ★ 10 points Multi-touch
- ★ Metal Cabinet with Diverse Installing Options
- ★ Made in Taiwan, 3 Years Warranty
- ★ Designed for all Environments
- ★ High Brightness Options
- ★ Anti-Glare/Reflection/Fingerprint/SPY... Options
- ★ All Kind of Connector Options (VGA/DVI/HDMI/DP)



			
BSMI	CE	FCC	RoHS
Compliance			

Records of Revision			
Vision	Modifying	Old Description	New Description
v1709.1	Frist Vision		

General Specifications

Display Specifications

Model No.	NTSP104 *	Pixel Pitch	0.264x0.264 mm
Screen Diagonal	10.4 inch	Response Time	16 msec
Display Area	211.2x162.7 mm	Backlight Unit	LED (white LED)
Resolution	800x600 (SVGA)	Viewing Angle (L/R,U/D)	160°/140° (CR \geq 10)
Brightness	400 nits (options)	Backlight Life Time	30000 HRS
Contrast Ratio	700:1	Operating Temp.	-20-70°C
Display Ratio	4:3	Surface Treatment	Anti-glare, Hardness 3H
Support Color	16.2M Color		

* Depends on specifications and options.

Brightness Options

Item	Brightness	Model No.
Standard	400 nits	NTSP104NX-XXXXXXXX-XXX
Enhanced *	1000 nits	NTSP104AX-XXXXXXXX-XXX
Enhanced *	1500 nits	NTSP104FX-XXXXXXXX-XXX

* For outdoor application.

Display Input Options

Item	Connectors	Model No.
Standard	VGA+DVI	NTSP104XX-XXXXX4X-XXX
Option	VGA+DVI+HDMI	NTSP104XX-XXXXX7X-XXX
Option	VGA+HDMI+DP	NTSP104XX-XXXXX3X-XXX

Audio Input

Item	Description	Connector
Audio Input	Stereo	TRS connector 3.5mm
Speaker	2W x2	

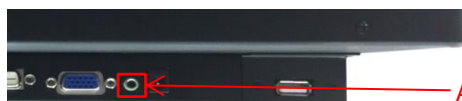

Audio Input



Speakers

Supported OS

OS	Version
Windows	Win10, Win8, Win7 , Vista, XP, Embedded XP, Win2000, CE.NET 4.x ↑
Linux	Kernel 2.6.24 ↑
Android	3.0 ↑
Mac	10.5.x ↑ (Intel CPU)

Physical Specifications

Dimension (Max)	257.7x214.1x45 mm	Net Weight	≤ 1.8 KG
Wall Mount Hole	75x75 mm	Gross Weight	≤ 2.66 KG

Cabinet Options

Item	Description
Standard	Galvanized steel (SECC)
Option	Stainless Steel
Option	Aluminum

Display Control Options

Item	Description
OSD (standard)	Physical button (standard)
Software (option)	Software Control via RS232 interface.



OSD Button



Software Control via RS232 interface.

Power Input Options

Item	Description	Connector
Standard	DC-12V, with AC/DC Adapter 100~240V	DC Jack Φ2.1mm
Option	DC-12V, with AC/DC Adapter 100~240V	DC Jack Φ2.1mm (Lockable) *

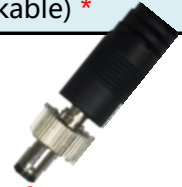

* Lockable Connector

Surface Film Options

AG	Anti-Glare	AR	Anti-Reflective
AFP	Anti-Fouling/Fingerprint	AS	Anti-Spy



Touch Specifications

Non-touch Model

Full Model No.	NTSP104N ₀ -XXXXXXX-XXX	Tempered Glass Thickness	2.0±0.2mm
		Glass Hardness	≥7H

Projected Capacitive Touch Model

Full Model No.	NTSP104N _P -XXXXXXX-XXX	Transparency	≥87%
Touch Screen	Projected Capacitive	Touch Screen Thickness	2.2±0.2mm
Allowed touch points	10 points	Hardness	≥7H
Interface	USB	Surface Treatment	AG coating

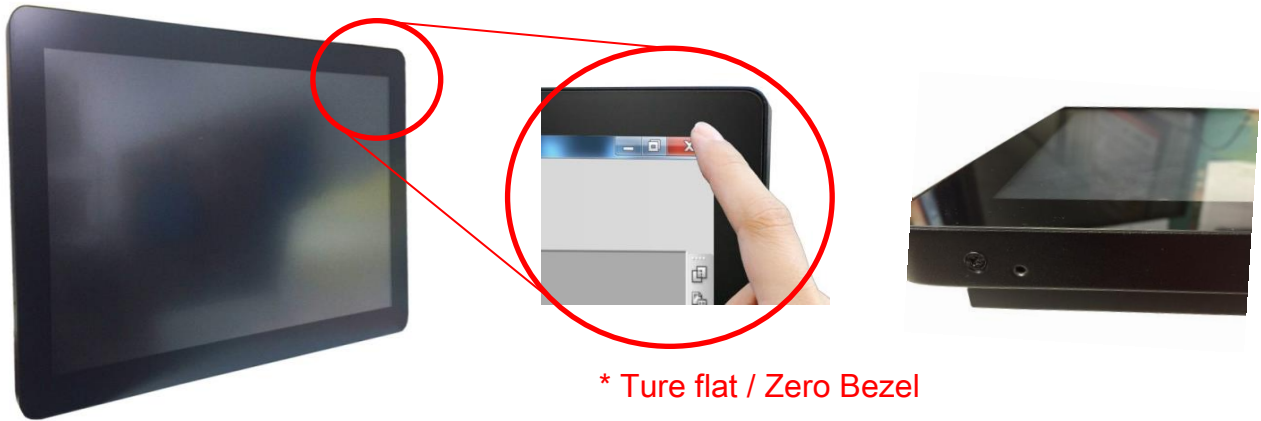

Accessories

Item	Description	Quantity
VGA Cable	D-Sub 15Pin Male to Male , 1.2 Meter	1
Audio cable	3.5mm Headset Jack , Male to Male , 1.2 Meter	1
AC-DC Adapter	4.16A/12V with CE/FCC/CCC/UL/RoHS/PSE/JET Certification	1
Power cord	*(depends on Country)	1
USB Cable	A type , Male to Male , 1.5 Meter *(only for touch models)	1



Outward and Dimensions

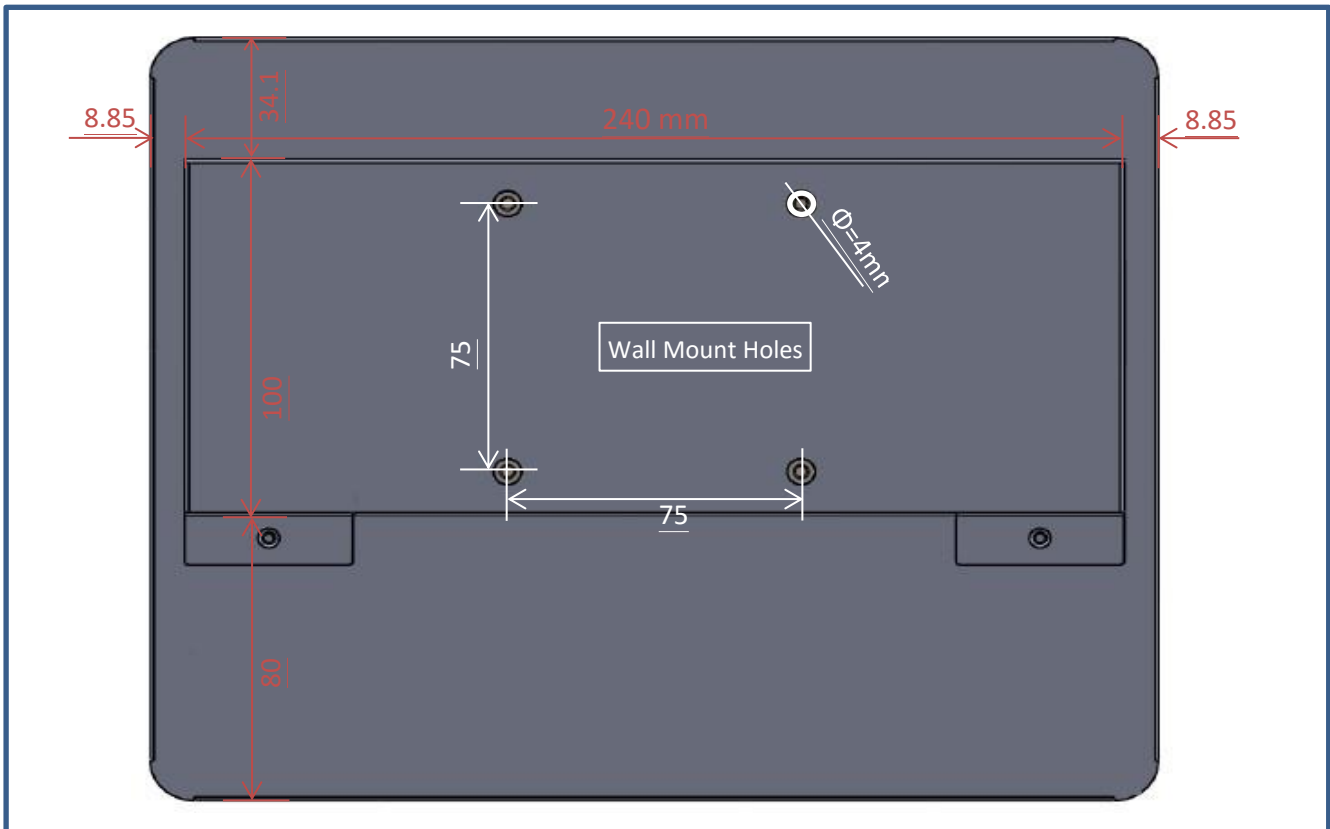
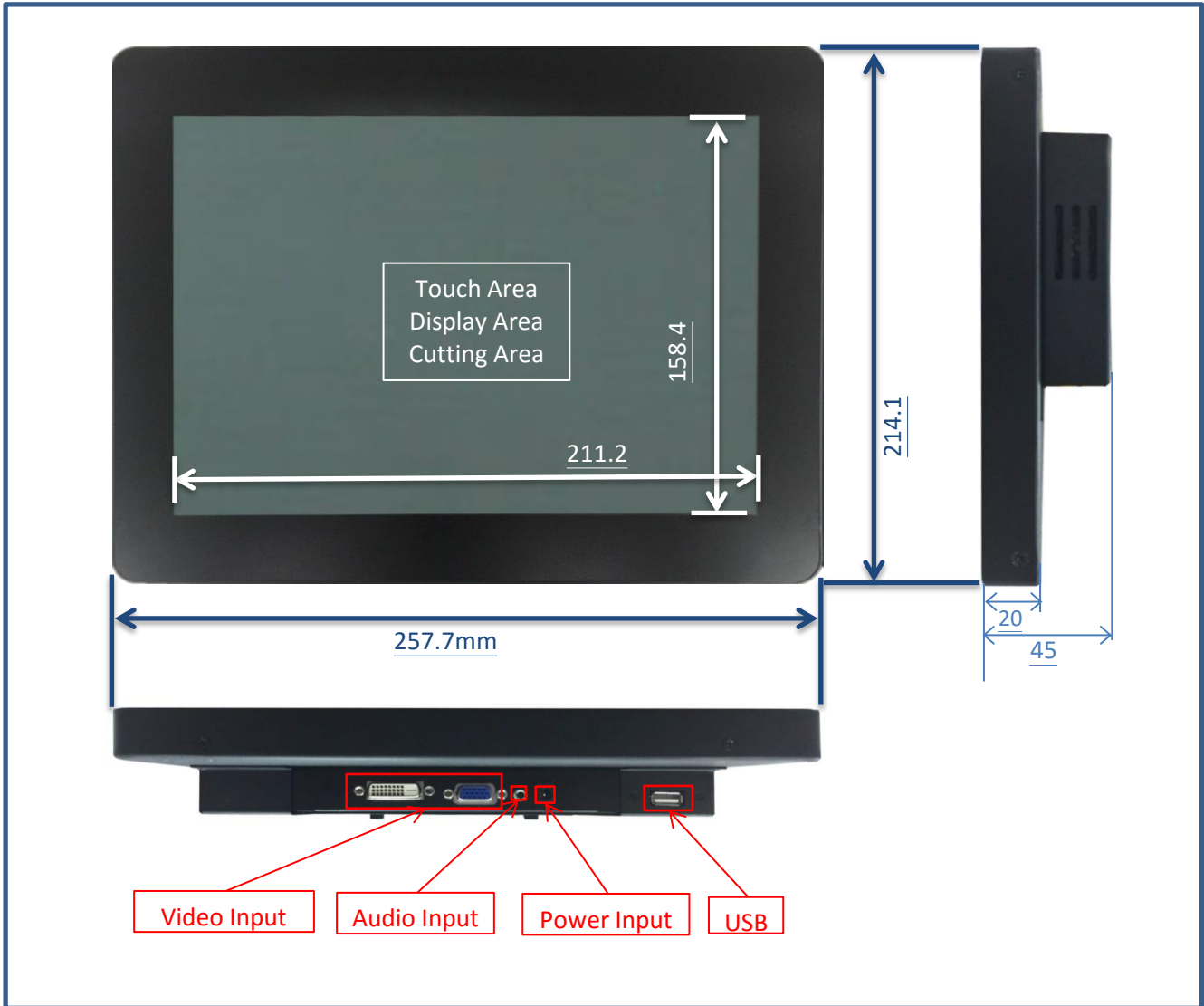

Optional Accessories (Desktop Stand)

Item	B Stand	Part No.	P1SS0 / P1SS0-02
Mounting Pattern	100x100 / 75x75 mm	Dimension (WxHxD)	203x275x227 mm
Material	Steel/Plastic/Aluminum	Net Weight	1.8 KG
Tilt(Hinge)	-2° ~ +180°	Support Max. Weight	15 KG

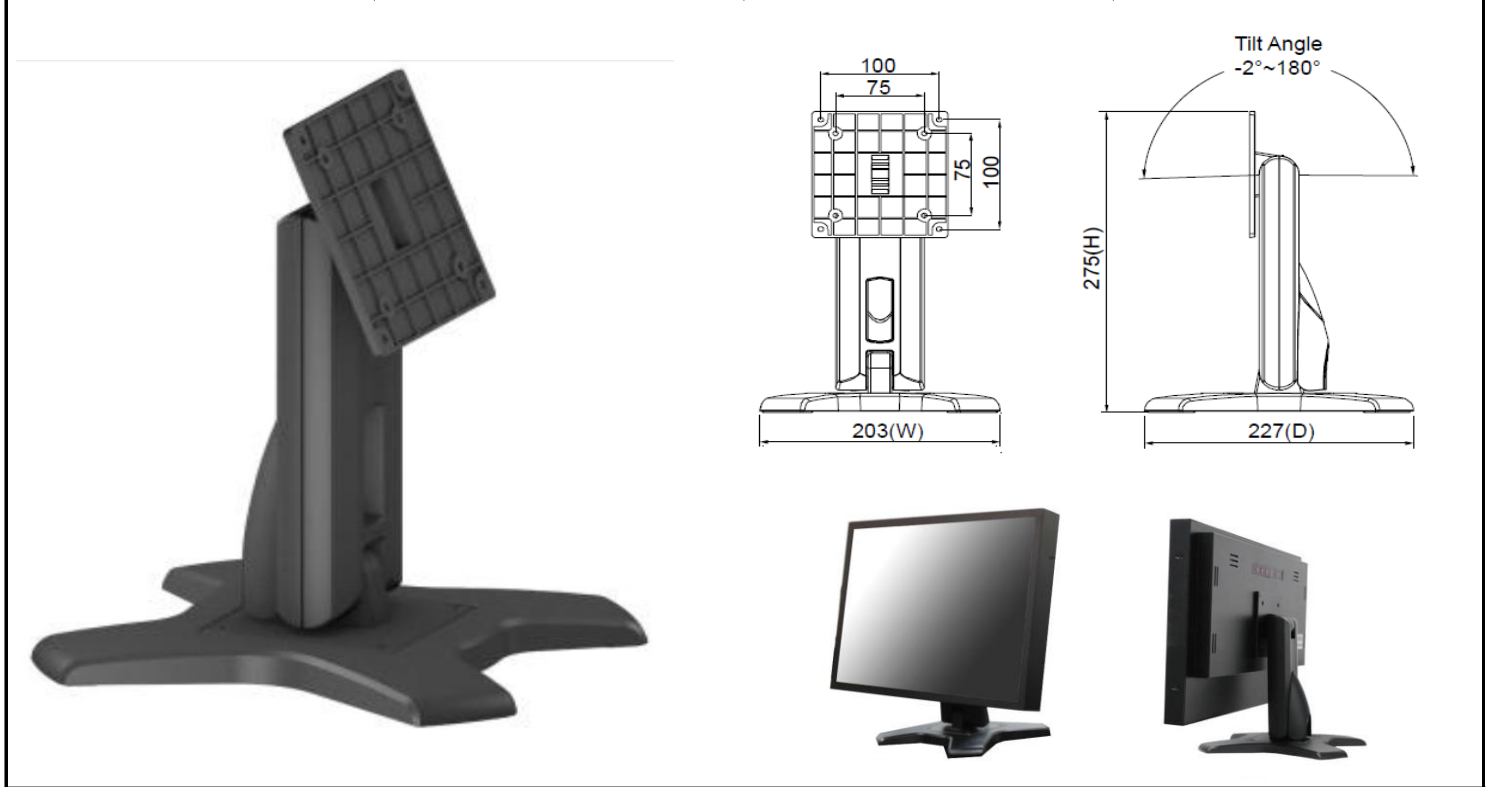

Item	Z Stand	Part No.	P1SZ2
Mounting Pattern	100x100 / 75x75 mm	Dimension (WxHxD)	190x240x41.6
Material	SECC	Net Weight	2.6 KG
Tilt(Hinge)	±360°	Support Max. Weight	15 KG

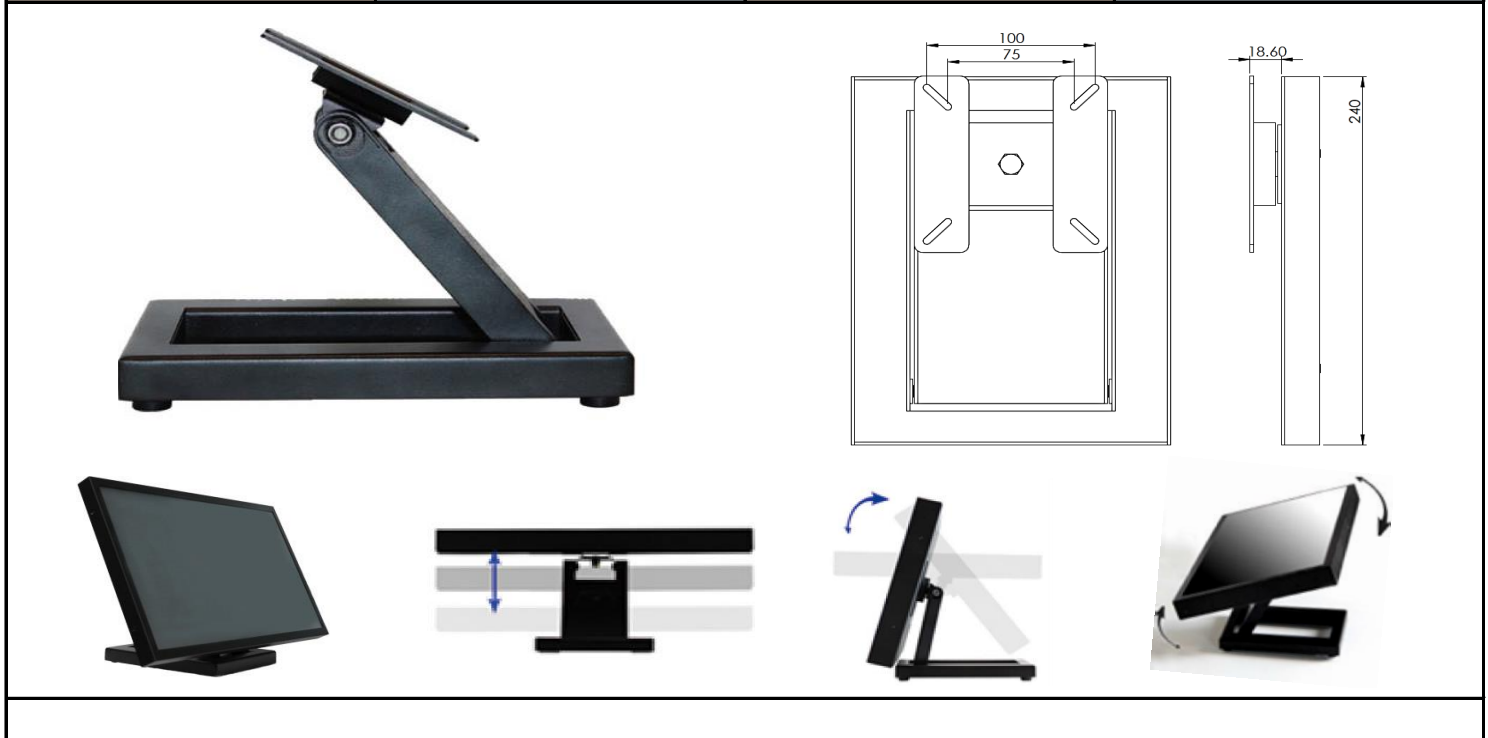

Optional Accessories (Open-frame Brackets)

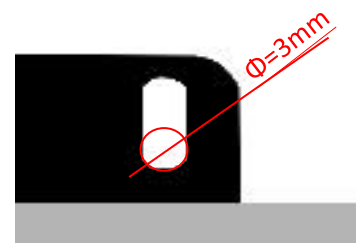
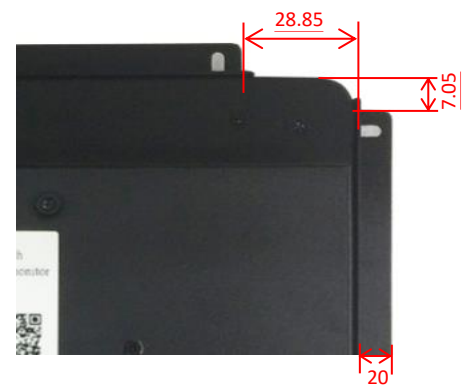

Optional Accessories (Wall Mount Bracket)

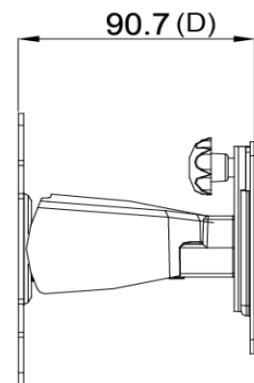
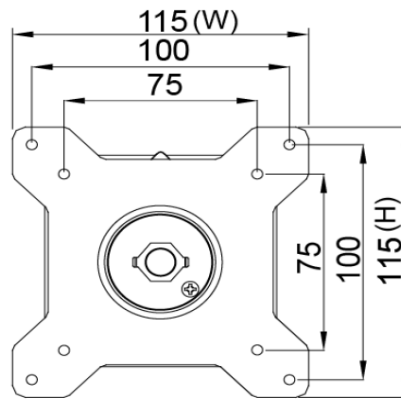
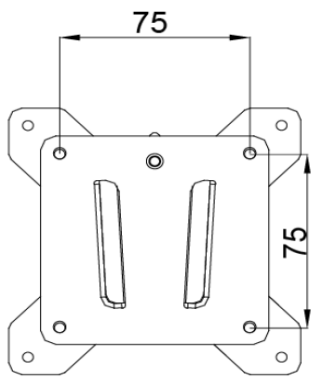

Packing Information



Net Weight	≤ 1.8 KG
Gross Weight	≤ 2.66 KG
Q'ty per Pallet	30 units
Pallet Size	120x100x15 CM
Total Size	120x100x150 CM
Total Weight	89 KG

Optional Accessories (Desktop Stand or Arm)



- 273x180x265 mm
 - 1.07 KG
 - Support 12 KG



- 620x556x123 mm
 - 3 KG
 - Support 10 KG



- 250x192x445 mm
 - 1.4 KG
 - Support 12 KG



- 655x858.5x563 mm
 - 7.56 KG
 - Support 30 KG



- 158x403x144 mm
 - 2.12 KG
 - Support 12 KG

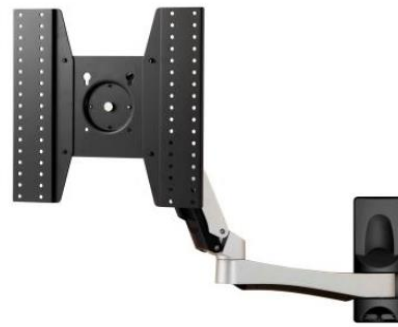

- 646x861x953.5 mm
 - 8.57 KG
 - Support 30 KG



- 423x403x240 mm
 - 1.91 KG
 - Support 12 KG



- 1300x403x307 mm
 - 5.3 KG
 - Support 8 KG



- 715x393x144 mm
 - 3.68 KG
 - Support 12 KG

