

Product Specifications

Customer	
Model	NTAP215 V400
Model No.	NTAP215<u>XX</u>-2<u>XX</u><u>XX</u>A2-400

* X = A~Z, 0~9 (Depends on Options.)



Records of Revision			
Vision	Modifying	Old Description	New Description
v1810.1	Frist Vision		
v1810.2	Format Updated		
v1810.4	Upgrade Android	Android 5.1	Android 9.0



Features

- ★ 21.5" , 16:9/1920x1080 (FHD) Resolution
- ★ VA Wide Viewing Angle Technology (178°/178°)
- ★ Rock Chip ARM Cortex A53 RK3368 1.5GHz CPU
- ★ On Board DDR3-1333 2G RAM
- ★ On Board 8G Flash ROM (Max. upgraded to 32G)
- ★ Android 9.0
- ★ True Flat Projected Capacitive Touch Screen
- ★ 7H Hardness Tempered Cover Glass
- ★ 10 points Multi-touch , Supports Active Stylus
- ★ Metal Cabinet with Diverse Combine Options
- ★ Made in Taiwan, 3 Years Warranty
- ★ Optional High Brightness 1500nits, for Outdoor Environment
- ★ Optional Antibacterial/Anti-Glare/AR/AF/AS Surface Treatment



Desktop Stand



Side Brackets



Wall Mounting



PSE



BSMI



FCC



CE



RoHS



ISO9001



System Specifications

CPU	64bit Octa-core ARM CORTEX-A53 1.5GHz
Memory	DDR3 2G
Storage	eMMC 8G, Max. Support 32G
GPU Chip	PowerVR SXG6110
Sound Chip	Realtek ALC662 Audio CODEC
Network	RJ45 10/100 Mbps, WIFI 802.11b/g/n
Power Input	12V DC

Display Specifications

Screen Diagonal	546.21mm (21.5 inch)	Display Mode	VA mode, Normally Black
Display Area	476.1x267.8 mm	Backlight Unit	LED (white LED)
Resolution	1920x1080 (FHD)	Viewing Angle (L/R, U/D)	178°/178° (CR=10)
Contrast Ratio	3000:1	Backlight Lifetime	>30,000 Hours
Display Ratio	16:9	Operating Temp.	0~50°C
Support Colors	16.7M Colors	Storage Temp.	-20~60°C
Pixel Pitch	247.95x247.95 um	Surface Treatment	Anti-glare, Hardness 3H
Response Time	18 msec.		

Display Options

Brightness			
	Brightness	Environment	Model Name
Standard	250nits	General (Indoor)	NTAP215NX-2XEXXA2-400
Option 1	1000nits	Outdoor Environment	NTAP215AX-2XEXXA2-400
Option 2	1500nits	Sunlight Readable	NTAP215FX-2XEXXA2-400

Touch Options

Projected Capacitive			
Model Name	NTAP215XP-2XEXXA2-400		
Touch Technology	Projected Capacitive	Thickness of Cover Lens	2.8±0.2mm
Allowed Touch Points	10 points	Hardness of Cover Lens	7H
Transparency	≥87%	IK Ratings	IK07
Accuracy	99.00%		



Non-Touch	
Model Name	NTAP215X0-2XEXXA2-400



System Options

Color of Cabinet		
	Description	Model Name
Standard	Silver	NTAP215XX-2BEXXA2-400
Option 1	White	NTAP215XX-2SEXXA2-400
Option 2	Black	NTAP215XX-2WEXXA2-400
Options	Other Color	NTAP215XX-2XEXXA2-400

* X = A~Z, 0~9 (Depends on Color)

Material of Cabinet		
	Description	Model Name
Standard	SECC	NTAP215XX-2XESXA2-400
Option 1	Stainless Steel	NTAP215XX-2XELXA2-400
Option 2	Aluminum	NTAP215XX-2XEAXA2-400

Cooling Fan		
	Description	Model Name
Standard	7 Blades/4000r.p.m/Max.10.96CFM	NTAP215XX-2XEXFA2-400
Option	Fanless	NTAP215XX-2XEX0A2-400

Other Options

Active Stylus (Option)	
Technology	Active Capacitive Coupled
Working Frequencies	90~250 KHZ
Pressure Level	256~1024 Levels
Side Buttons	2 Side Buttons (Eraser, Barrel)
Active Tip Force	5~25g
Max. Tip Force	400g



Surface Treatment Options	
Standard	(none)
Option	Anti-Glare Coating
Option	Antibacterial (AB Film)
Option	Anti-Glare +UV-Cut (AG+UV Film)
Option	Anti-Glare +Fouling/Fingerprint (AG+AFP Film)
Option	Anti-Reflective +Fouling/Fingerprint (AR+AFP Film)
Option	Anti-Glare +Reflective +Fouling/Fingerprint (AG+AR+AFP Film)
Option	Anti-Spy (AS Film)



Input /Output System

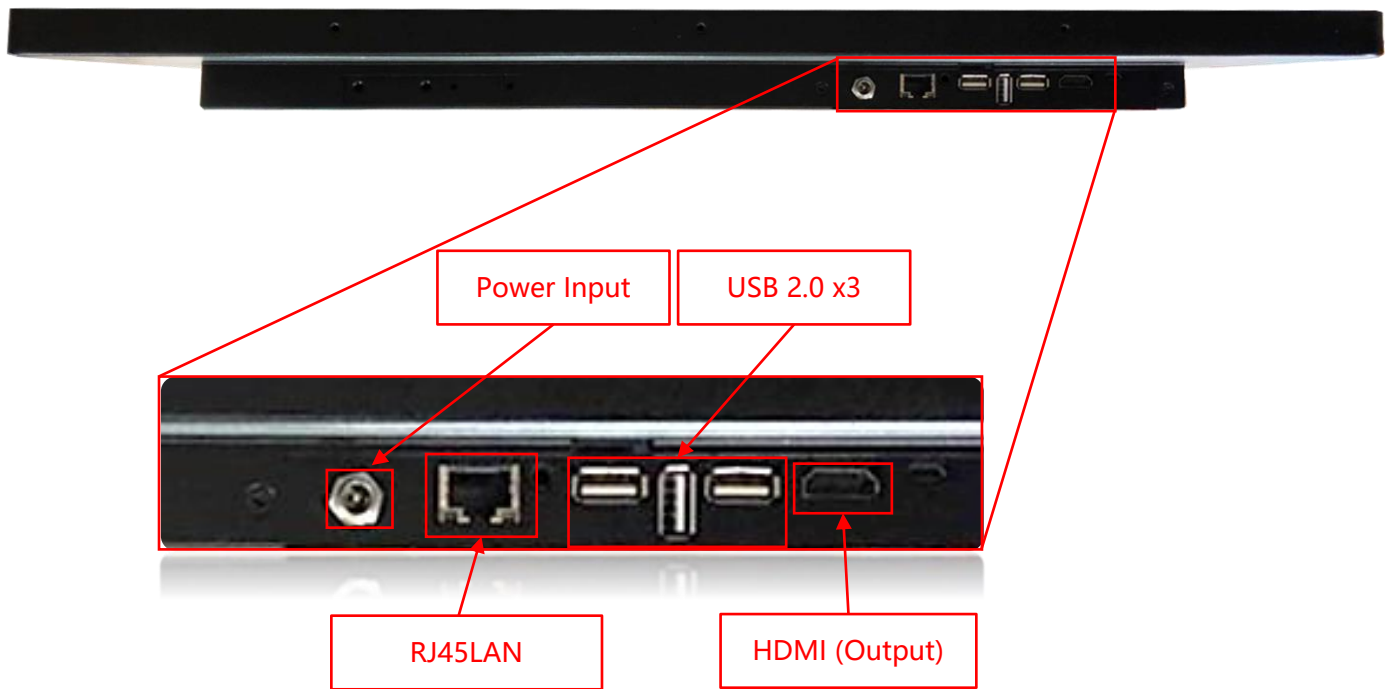

Input / Output	Connectors	Input / Output	Connectors
HDMI (Output)	1	DC Power Input	2
USB 2.0	3	Speakers	2W x2
LAN (RJ45)	1		

Desktop Stand (Option)

Item	B Stand	Part No.	DST-0B002/DST-1B002
Mounting Pattern	100x100 / 75x75 mm	Dimension (WxHxD)	203x275x227 mm
Material	Steel/Plastic/Aluminum	Net Weight	1.8 KG
Tilt (Hinge)	-2° ~ +180°	Support Max. Weight	15 KG



Item	Z Stand	Part No.	DST-0BZ01/DST-1BZ01
Mounting Pattern	100x100 / 75x75 mm	Dimension (WxHxD)	190x240x41.6
Material	SECC	Net Weight	2.6 KG
Tilt (Hinge)	±360°	Support Max. Weight	15 KG



Front Cover (Option)

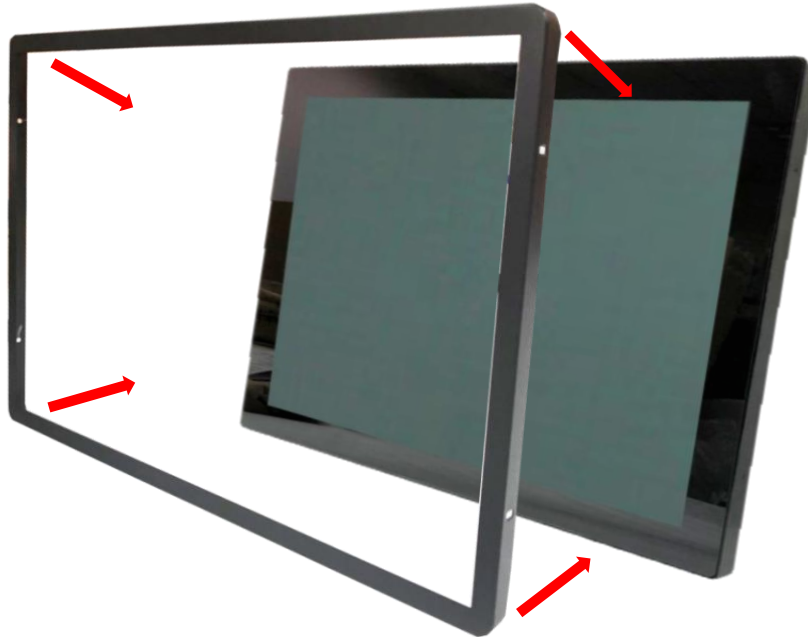

The standard **NTAP215** is true flat surface, with only 1mm metal bezel.
To protect the corners of the touch screen, the **Front Cover** can be added.



The watertight gasket can be added between the **Front Cover** and **NTAP215**.
It complies **IP65** on front.

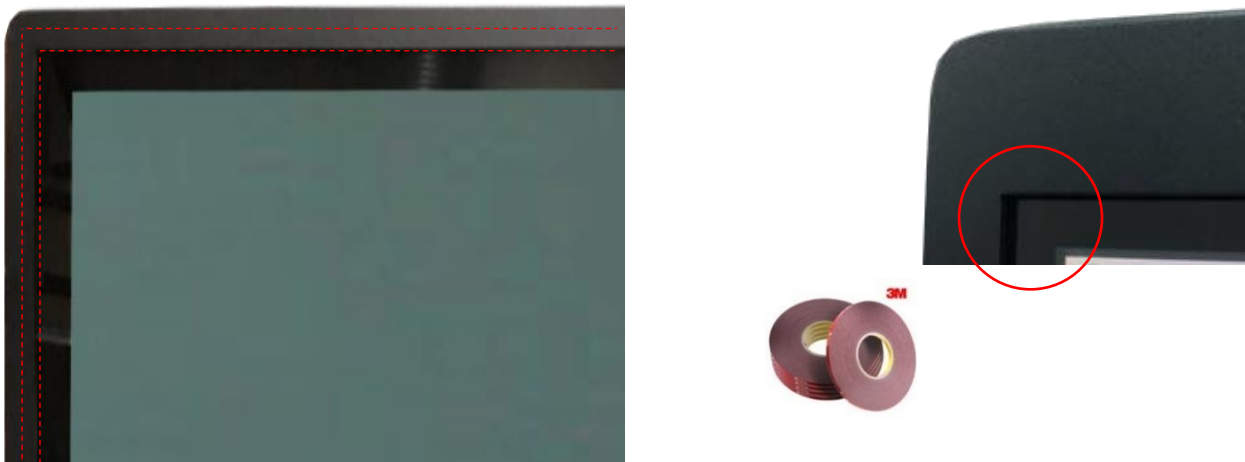

Open-frame Brackets (Option)

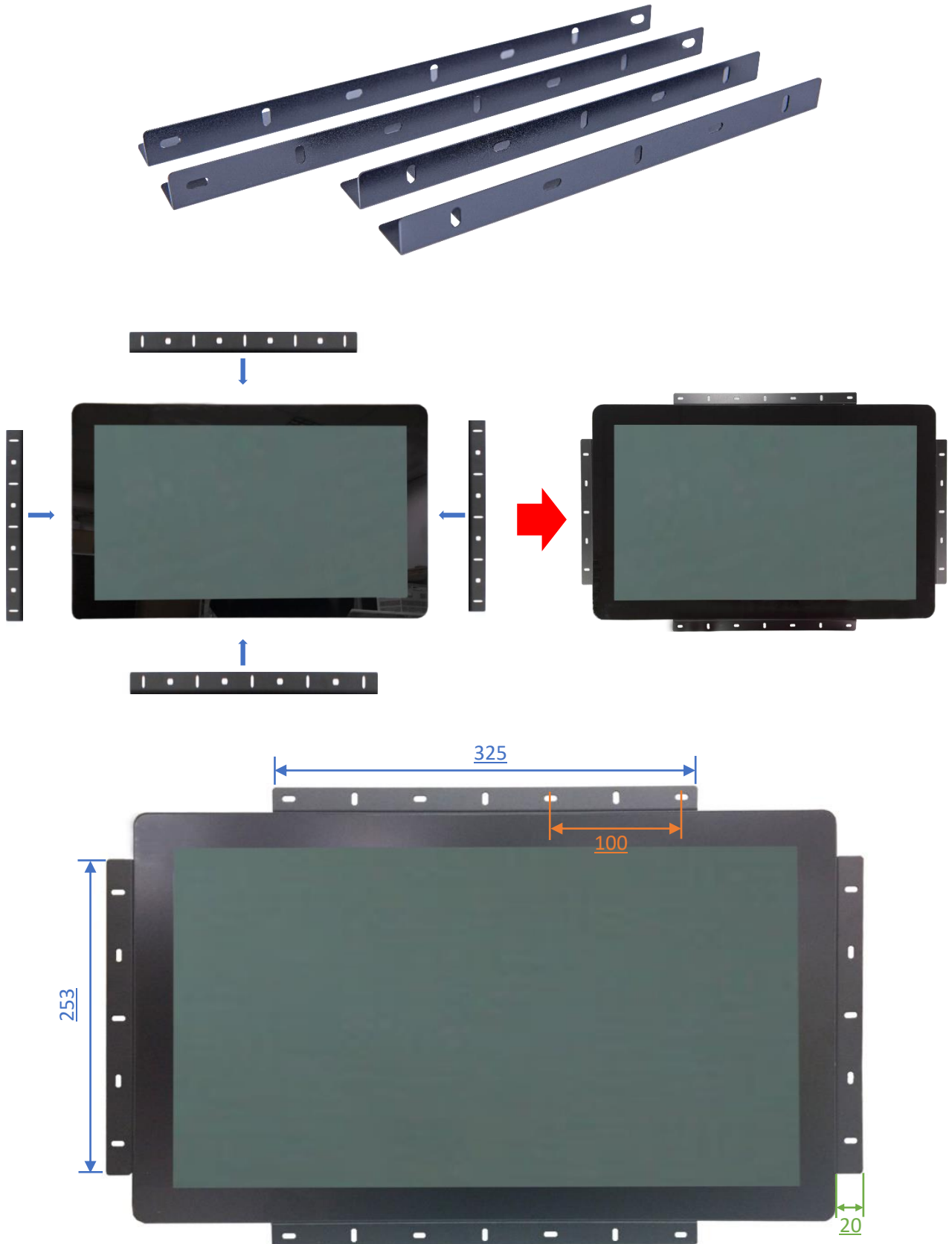

Wall Mount Bracket (Option)

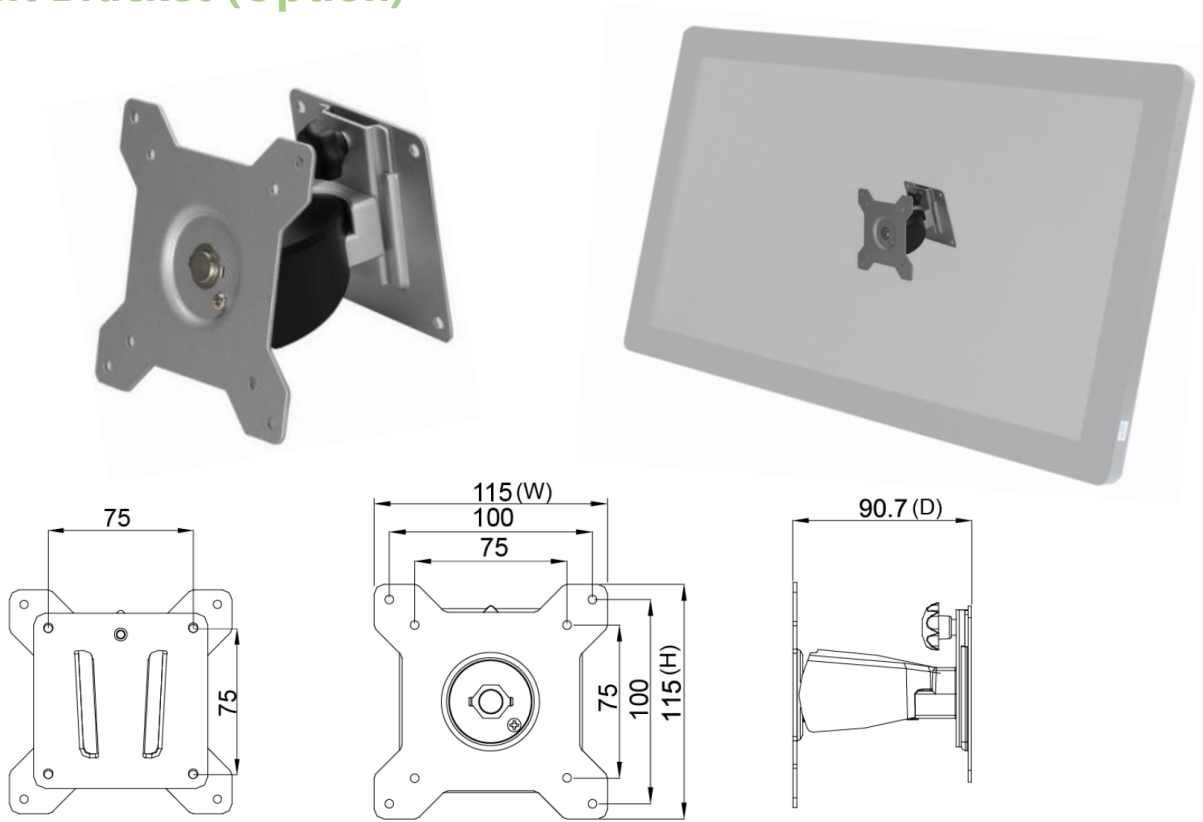

Packing Information



Dimensions of Carton	643x510x332 mm
Net Weight	≤ 4.6 KG
Gross Weight	≤ 7.4 KG

Physical Specifications

Dimension (Max)	536x327x40(±1)mm	Net Weight	≤ 4.6 KG
VESA Mounting	100x100 mm	Gross Weight	≤ 7.4 KG

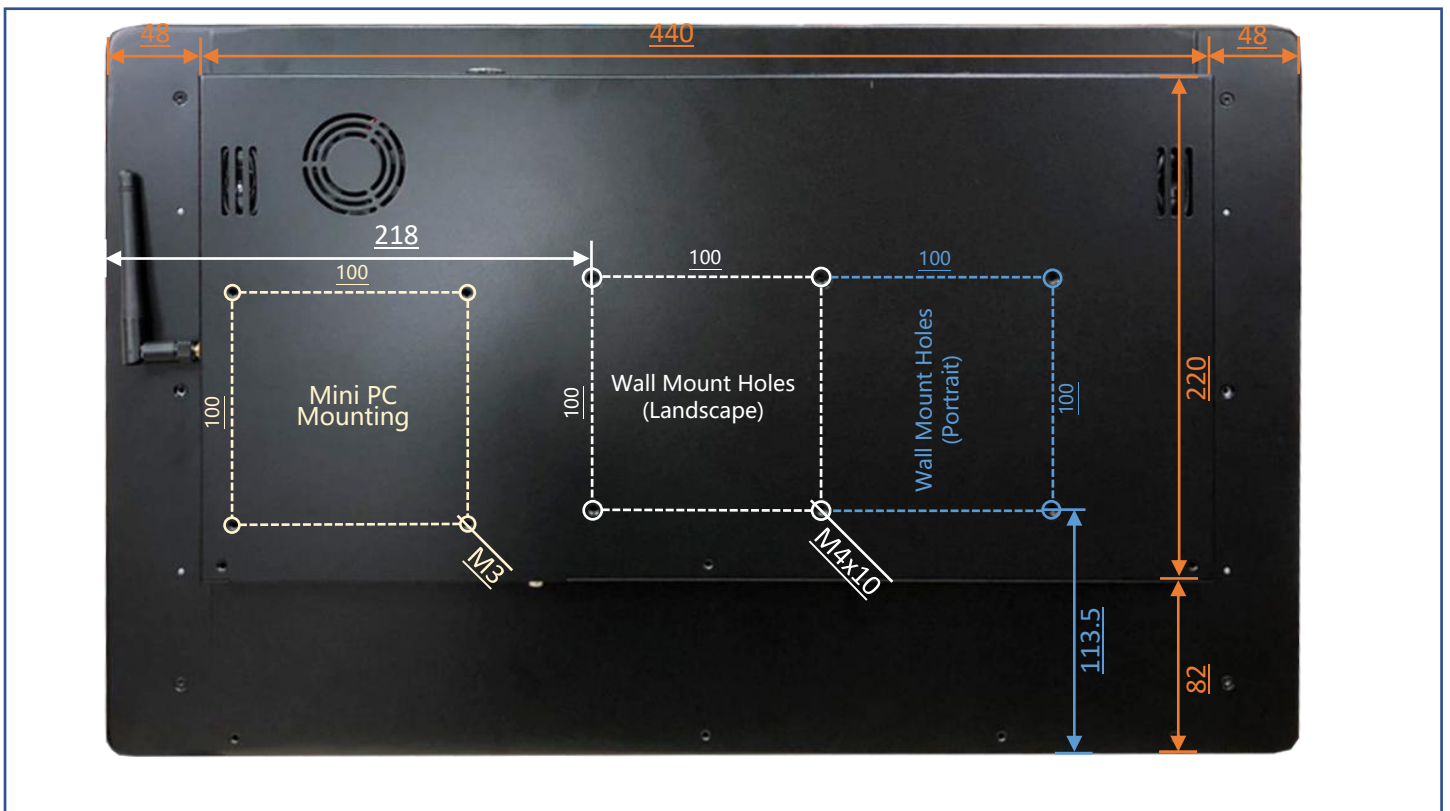
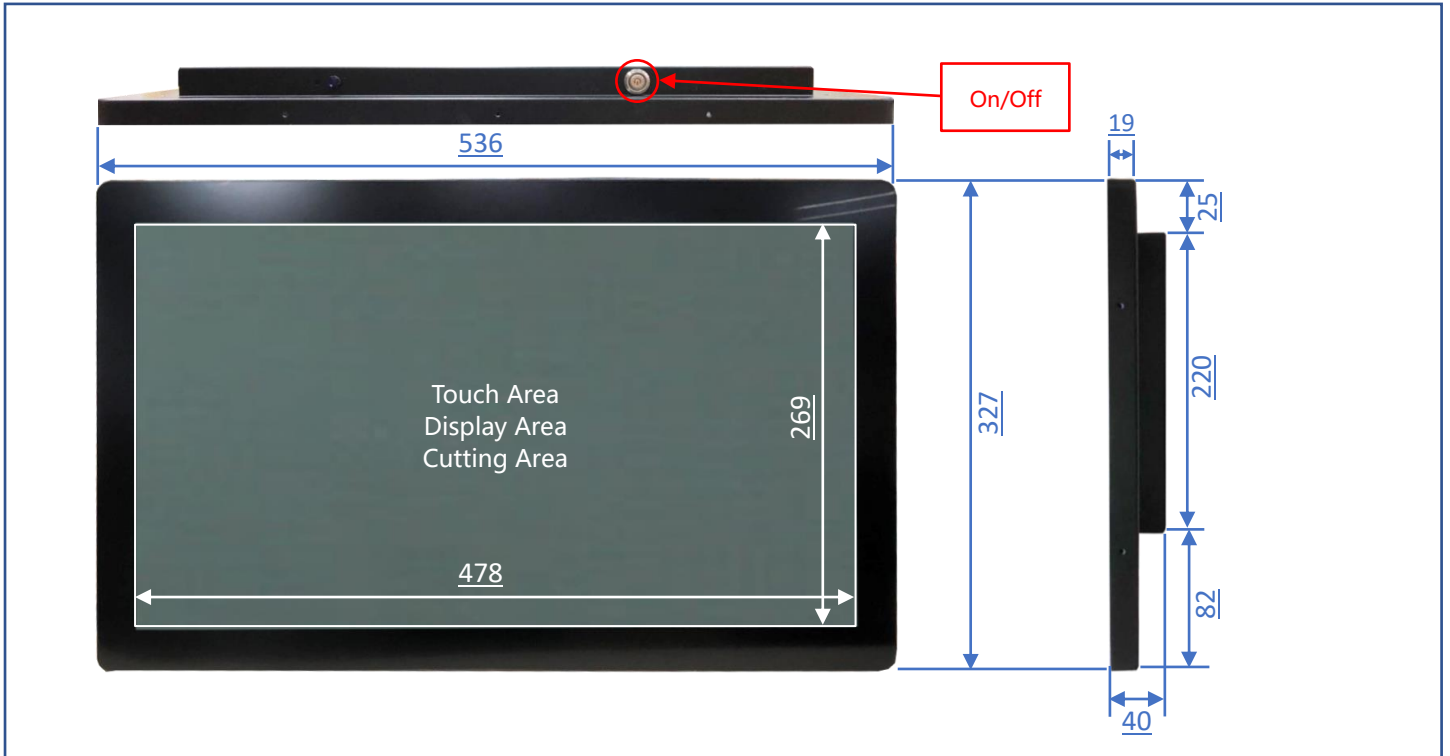

Cosmetic Inspection Standard

Display Area Allowance			
Defect description	Defective Specifications	Allowance	Remarks
Dot Defect (including dark dot, particles, bubbles, pits, dust, foreign matter)	$D \leq 0.2\text{mm}$	Ignored	D=Diameter
	$0.2 < D \leq 0.7\text{mm}$	$N \leq 5$	N=Quantity
	$0.7 < D \leq 1\text{mm}$	$N \leq 3$	
	$D > 1\text{mm}$	$N \leq 0$	
Linear Defect (including scratches, fluff, particles)	$W \leq 0.15\text{mm}$	Ignored	W=Width
	$0.15 < W \leq 0.5\text{mm}, L \leq 15\text{mm}$	$N \leq 2$	L=Length
	$W > 0.5\text{mm}$ or $L > 15\text{mm}$	NG	

* Visual inspection distance: 60cm, 90 degree (same for front/side/back)

Front Appearance Allowance (Including Coating)			
Defect description	Defective Specifications	Allowance	Remarks
Dot Defect (including particles, bubbles, pits...etc.)	$D \leq 0.7\text{mm}$	Ignored	D=Diameter
	$0.7 < D \leq 1.5\text{mm}$	$N \leq 3$	N=Quantity
	$D > 1.5\text{mm}$	$N \leq 0$	
Linear Defect (including scratches, fluff, particles)	$W \leq 0.2\text{mm}, L \leq 15\text{mm}$	Ignored	W=Width, L=Length
	$0.2 < W \leq 0.7\text{mm}, L \leq 15\text{mm}$	$N \leq 1$	
	$W > 0.7\text{mm}$ or $L > 15\text{mm}$	NG	

Side / Back Appearance Allowance (Including Coating)			
Defect description	Defective Specifications	Allowance	Remarks
Dot Defect (including particles, bubbles, pits...etc.)	$D \leq 1.5\text{mm}$	Ignored	D=Diameter
	$1.5 < D \leq 3\text{mm}$	$N \leq 8$	N=Quantity
	$D > 3\text{mm}$	$N \leq 2$	
Linear Defect (including scratches, fluff, particles)	$W \leq 0.8\text{mm}, L \leq 15\text{mm}$	Ignored	W=Width, L=Length
	$0.8 < W \leq 1.5\text{mm}, L \leq 15\text{mm}$	$N \leq 5$	
	$W > 1.5\text{mm}$ or $L > 15\text{mm}$	NG	

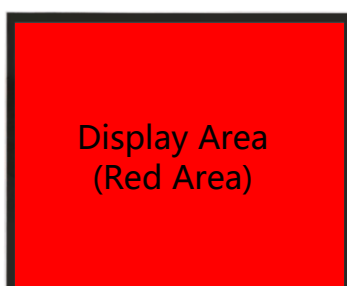

Display Area
(Red Area)



Front Appearance (Red Area)



Back Appearance