



Product Specifications

Customer	
Model Name	NTWP238-1 V500
Model Number	NTWP238<u>XXSXX</u>-GI<u>XXXXXX</u>-<u>XXFX</u>-500

* X = A~Z, 0~9 (Depends on Options.)



Records of Revision			
Vision	Modifying	Old Description	New Description
v2109.1	Preliminary Specification		



Features

- ★ 23.8 inch, 1920x1080 (FHD) Resolution
- ★ VA Wide Viewing Angle Technology (178°/178°)
- ★ Intel® 8th Generation Core i Series CPU
- ★ DDR4 8G RAM (Max. 32G)
- ★ M.2 x1, Serial ATAIIIx2, mSATA/mPCIe x1
- ★ Narrow Bezel, True Flat Projected Capacitive Touch Screen
- ★ 7H Hardness Tempered Cover Glass
- ★ 10 points Multi-touch , Supports Active Stylus
- ★ Metal Cabinet with Diverse Combine Options
- ★ Made in Taiwan, 3 Years Warranty
- ★ Optional High Brightness 1500nits, for Outdoor Environment
- ★ Optional AG Coating/Antibacterial/Privacy Filter Surface Treatment



PSE



BSMI



RoHS



CE



ISO9001



FCC



Desktop Stand



Wall Mounting



Open-frame Brackets



Panel Mount



System Specifications

CPU	Intel® 8th Generation Core i Series CPU
Memory	DDR4 SO-DIMM x2, Max. 32G
Storage	M.2 x1, mSATA/mPCIe x1, SATA x2
GPU	Intel® HD Graphics 620
Sound Chip	Realtek ALC269 Audio CODEC
Network	Intel Gigabit LAN, RJ45 ports x2

Display Specifications

Screen Diagonal	23.8 inch	Display Mode	VA Mode, Normally Black
Display Area	527.04x296.46 mm	Backlight Unit	LED (white LED)
Resolution	1920x1080 (FHD)	Viewing Angle (L/R, U/D)	178°/178° (CR=10)
Contrast Ratio	3000:1	Backlight Lifetime	>30,000 Hours
Display Ratio	16:9	Operating Temp.	0~50°C
Support Colors	16.7M Colors	Storage Temp.	-20~60°C
Pixel Pitch	274.5x274.5 um	Surface Treatment	Anti-glare, Hardness 3H
Response Time	16 msec.		

Display Options

Brightness			
	Brightness	Environment	Model Name
Standard	250nits	General	NTWP238NXSXX-GIXXXXX-XXFX-500
Option 1	1000nits	Outdoor Environment	NTWP238AXSXX-GIXXXXX-XXFX-500
Option 2	1500nits *	Sunlight Readable	NTWP238FX2XX-GIXXXXX-XXFX-500

* Check the data sheets: NTWP238-1 V500

Touch Options

Projected Capacitive			
Model Name	NTWP238 <u>P</u> SXX-G <u>I</u> XXXXX- <u>XX</u> FX-500		
Touch Technology	Projected Capacitive	Thickness of Cover Lens	2.9±0.2mm
Allowed Touch Points	10 points	Hardness of Cover Lens	7H
Transparency	≥87%	IK Ratings	IK07
Accuracy	99.00%		

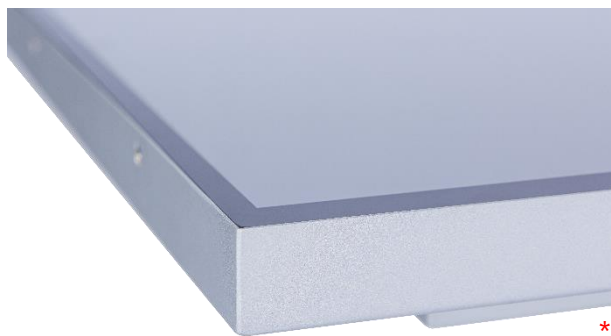

* True Flat, 1mm Bezel

Non-Touch	
Model Name	NTWP238 <u>0</u> SXX-G <u>I</u> XXXXX- <u>XX</u> FX-500

Surface Treatment Options		
	Description	Model Name
Standard	(none)	NTWP238XXS<u>00</u>-G<u>I</u>XXXXX-<u>XX</u>FX-500
Option 1	Anti-Glare Coating	NTWP238XXS <u>GG</u> -G <u>I</u> XXXXX- <u>XX</u> FX-500
Option 2	Antibacterial (AB Film)	NTWP238XXS <u>AB</u> -G <u>I</u> XXXXX- <u>XX</u> FX-500
Option 3	Anti-Spy (AS Film)	NTWP238XXS <u>SF</u> -G <u>I</u> XXXXX- <u>XX</u> FX-500



System Options

CPU		
	Item	Model Name
Standard	Intel® Core i3-8145U	NTWP238XXSXX-GI38XXX-XXFX-500
Option 1	Intel® Core i5-8265U	NTWP238XXSXX-GI 58 XXX-XXFX-500
Option 2	Intel® Core i7-8565U	NTWP238XXSXX-GI 78 XXX-XXFX-500

Memory		
	Item	Model Name
Standard	DDR4 SO-DIMM 8G	NTWP238XXSXX-GIXX8XX-XXFX-500
Option 1	DDR4 SO-DIMM 16G	NTWP238XXSXX-GIXX A XX-XXFX-500
Option 2	DDR4 SO-DIMM 32G	NTWP238XXSXX-GIXX B XX-XXFX-500

Storage		
	Item	Model Name
Standard	SSD 128G	NTWP238XXSXX-GIXXXS1-XXFX-500
Option 1	SSD 256G	NTWP238XXSXX-GIXXX S2 -XXFX-500
Option 2	SSD 512G	NTWP238XXSXX-GIXXX S3 -XXFX-500
Option 3	SATA HDD 1T	NTWP238XXSXX-GIXXX H1 -XXFX-500

System Options (Continued)

Material of Cabinet		
	Description	Model Name
Standard	SECC	NTWP238XXSXX-GIXXXXXX-<u>S</u>XF_X-500
Option 1	Stainless Steel	NTWP238XXSXX-GIXXXXXX- <u>L</u> XF _X -500
Option 2	Aluminum	NTWP238XXSXX-GIXXXXXX- <u>A</u> XF _X -500

Color of Cabinet		
	Description	Model Name
Standard	Silver	NTWP238XXSXX-GIXXXXXX-<u>X</u>SF_X-500
Option 1	White	NTWP238XXSXX-GIXXXXXX- <u>X</u> WF _X -500
Option 2	Black	NTWP238XXSXX-GIXXXXXX- <u>X</u> BF _X -500
Options	Other Color	NTWP238XXSXX-GIXXXXXX- <u>X</u> XF _X -500

* X = A~Z, 0~9 (Depends on Color)

Power Input		
	Description	Model Name
Standard	9~24DC-in, with AC/DC Adapter	NTWP238XXSXX-GIXXXXXX-<u>XXF</u>₃-500
Option	100~240V AC, C14 AC Power Socket	NTWP238XXSXX-GIXXXXXX- <u>XXF</u> _A -500



DC-in



AC-in

Input /Output System

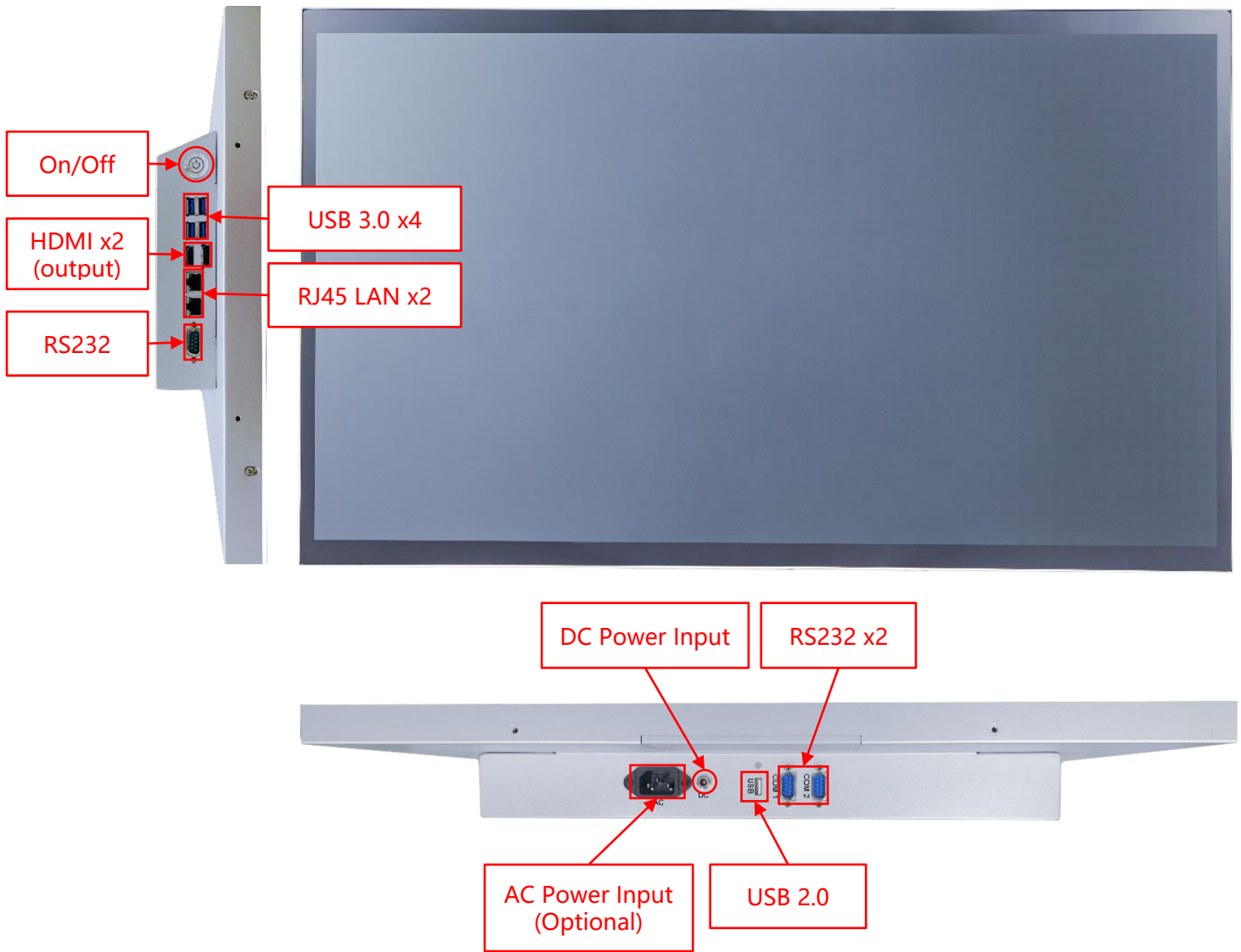

Input / Output	Connectors	Input / Output	Connectors
HDMI (Output)	2	Speakers	2W x2
USB 3.0	4	DC Power Input	1
USB 2.0	1	AC Power Input	Option
RS232	3	Wi-Fi/Bluetooth & Antenna	Option
LAN (RJ45)	2		

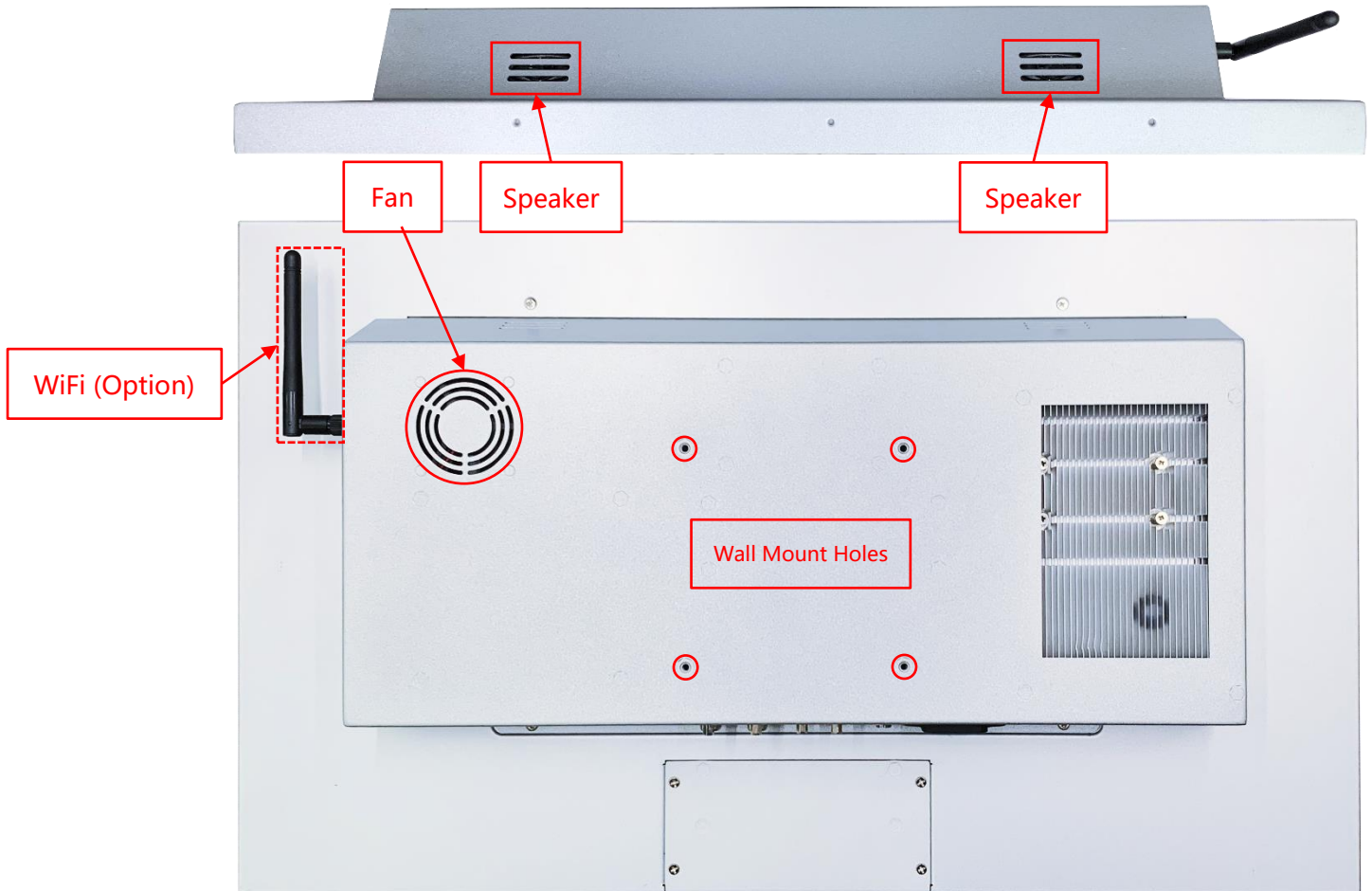

Other Options

Wireless Network (Option)	
Spec	Wi-Fi a/b/g/n/ac, Dual Mode Bluetooth 2.1/2.1+EDR,3.0,3.0+HS,4.0 (BLE) (Wi-Fi+BT4.0)

Active Stylus (Option)	
Technology	Active Capacitive Coupled
Working Frequencies	90~250 KHZ
Pressure Level	256~1024 Levels
Side Buttons	2 Side Buttons (Eraser, Barrel)
Active Tip Force	5~25g
Max. Tip Force	400g

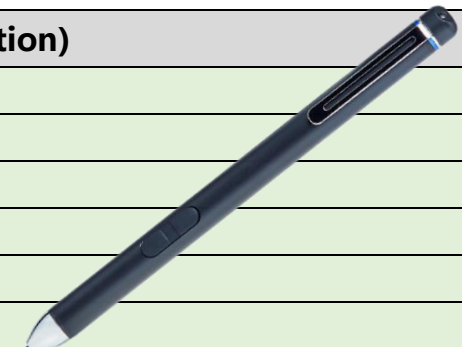

Front Cover (Option)

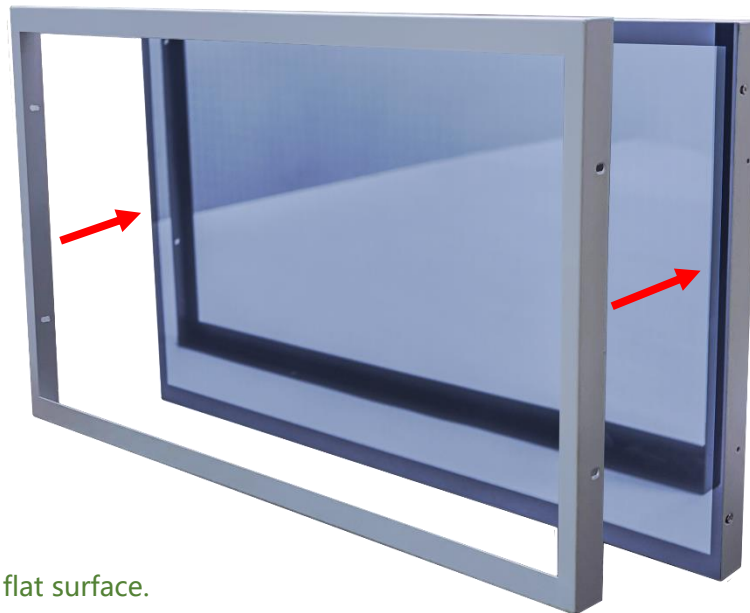

The standard **NTWP238** is true flat surface.

To protect the corners of the touch screen, the Front Cover can be added.



The watertight gasket can be added between the Front Cover and **NTWP238**.

It complies **IP65** on front.

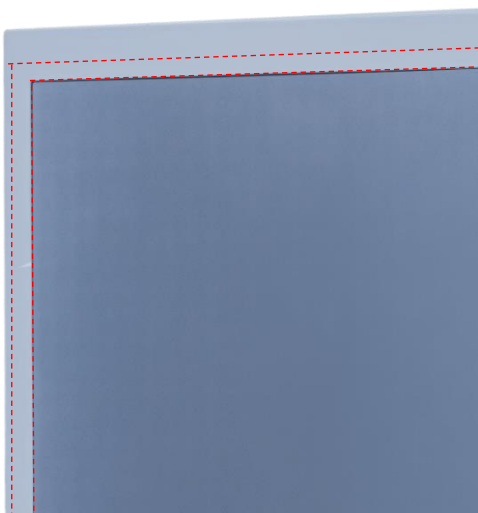

Open-frame Brackets (Option)

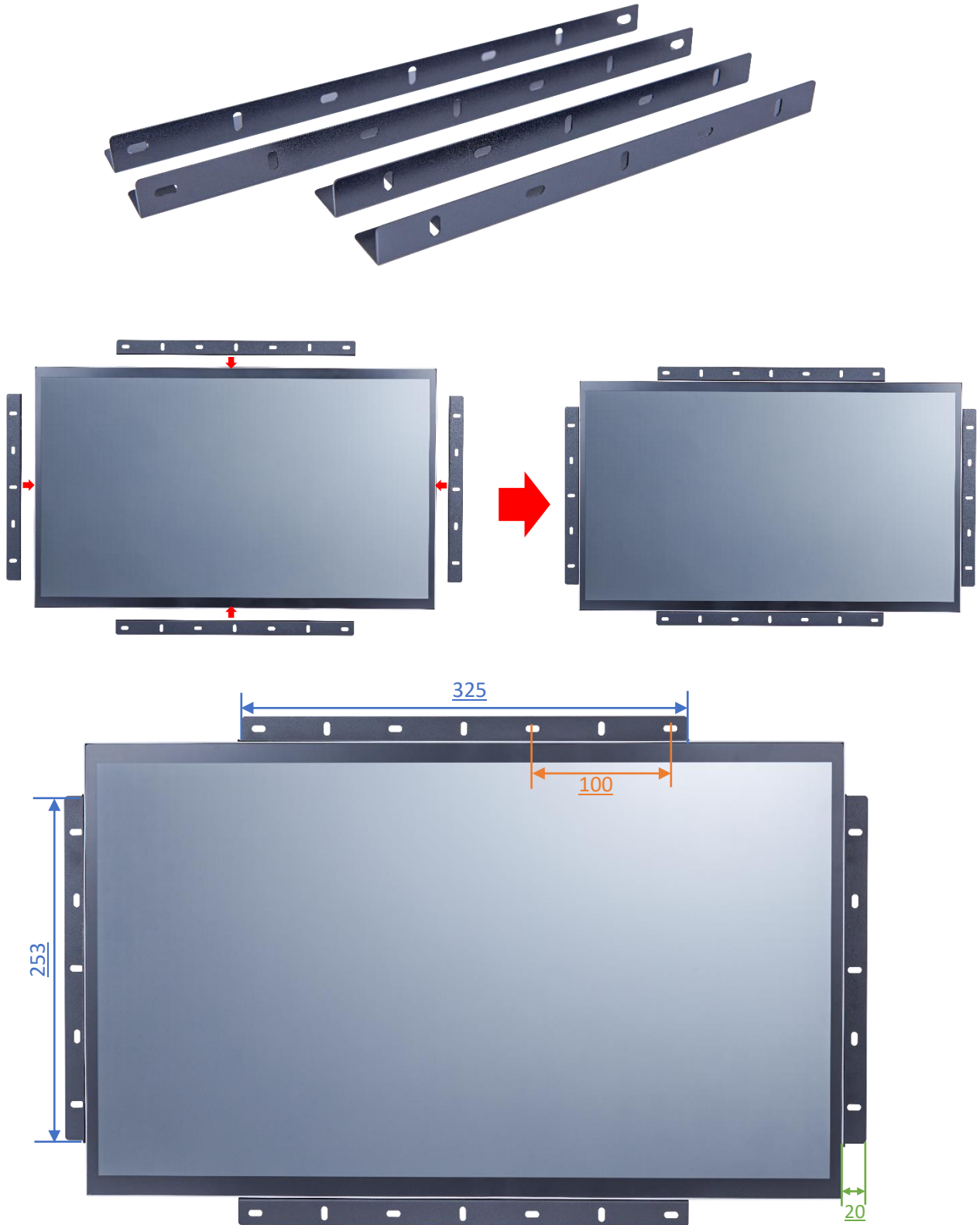

Panel Mount Kits (Option)

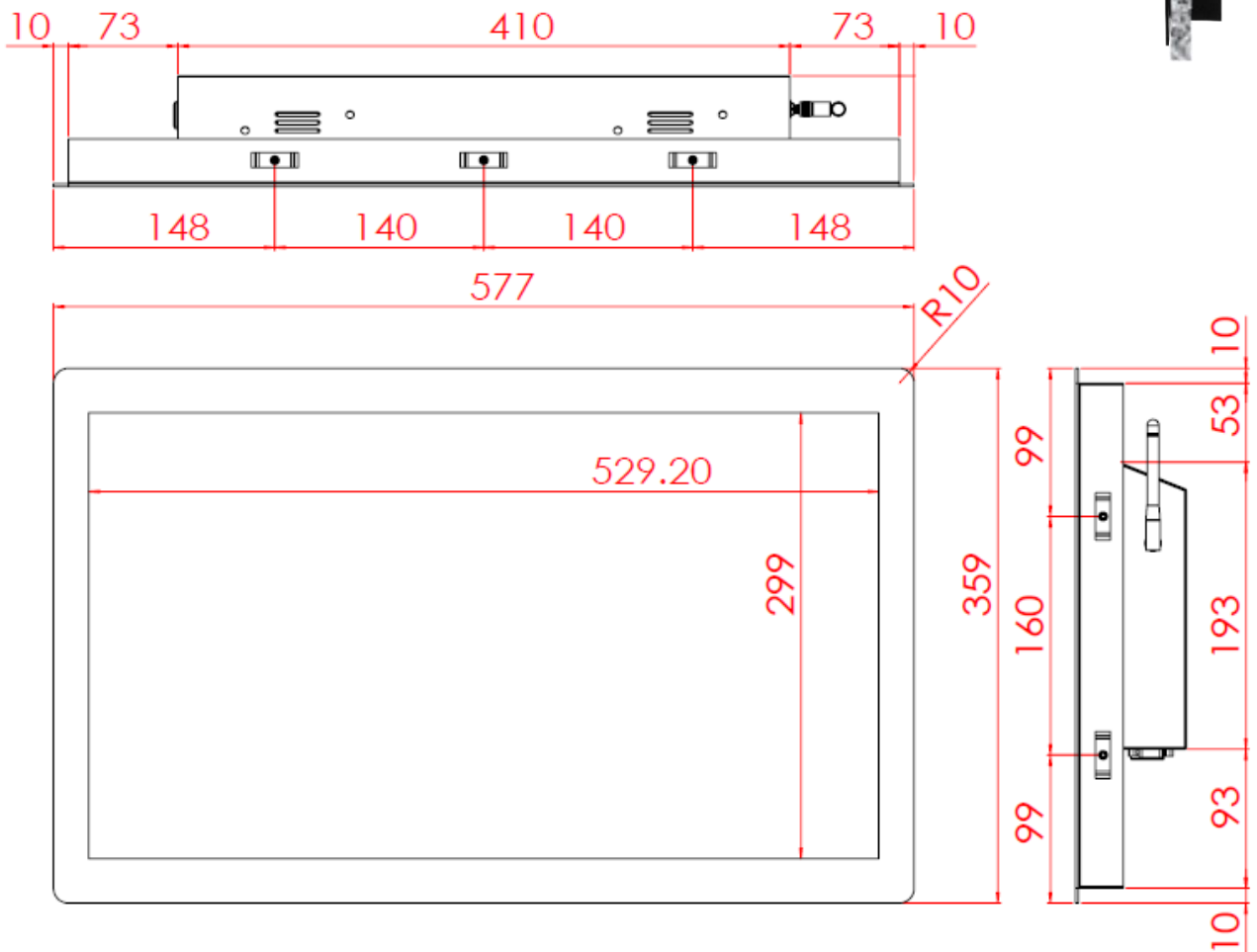

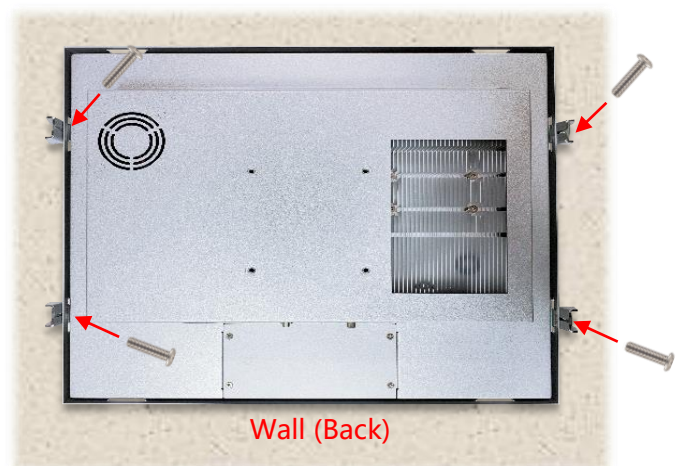
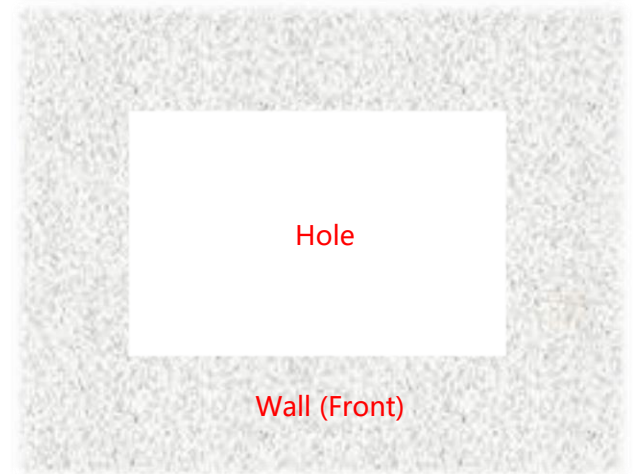
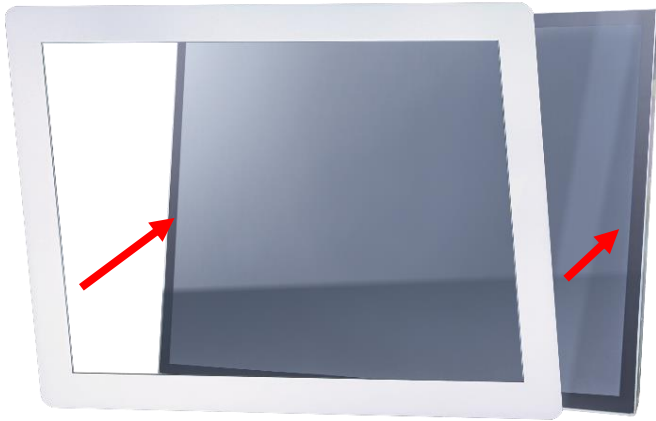

Desktop Stand (Option)

Item	B Stand	Part No.	DST-0B002/DST-1B002
Mounting Pattern	100x100 / 75x75 mm	Dimension (WxHxD)	203x275x227 mm
Material	Steel/Plastic/Aluminum	Net Weight	1.8 KG
Tilt (Hinge)	-2° ~ +180°	Support Max. Weight	15 KG



Item	Z Stand	Part No.	DST-0BZ01/DST-1BZ01
Mounting Pattern	100x100 / 75x75 mm	Dimension (WxHxD)	190x240x41.6
Material	SECC	Net Weight	2.6 KG
Tilt (Hinge)	±360°	Support Max. Weight	15 KG



Wall Mount Bracket (Option)

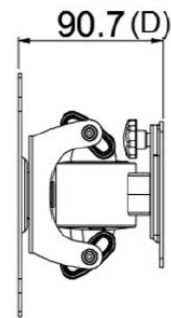
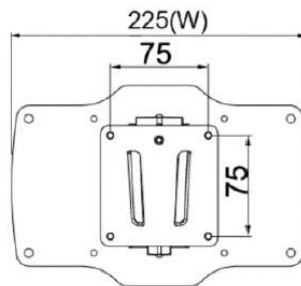
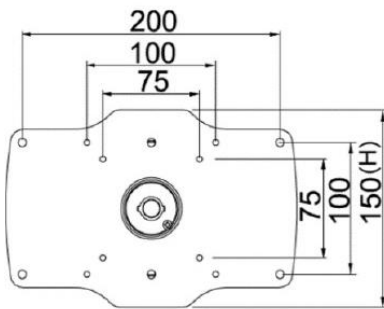
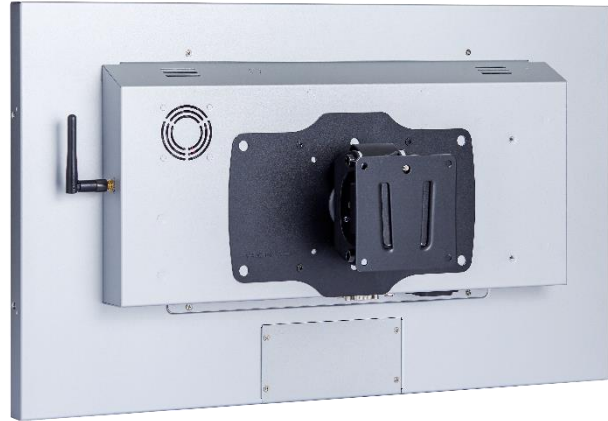

Packing Information



Dimensions of Carton	772x200x523 mm
Net Weight	≤6.4 KG
Gross Weight	≤8.4 KG

Physical Specifications

Dimension	547x329x71(±2)mm (w/o Antenna)	Net Weight	≤6.4 KG
VESA Mounting	100x100 mm	Gross Weight	≤8.3 KG

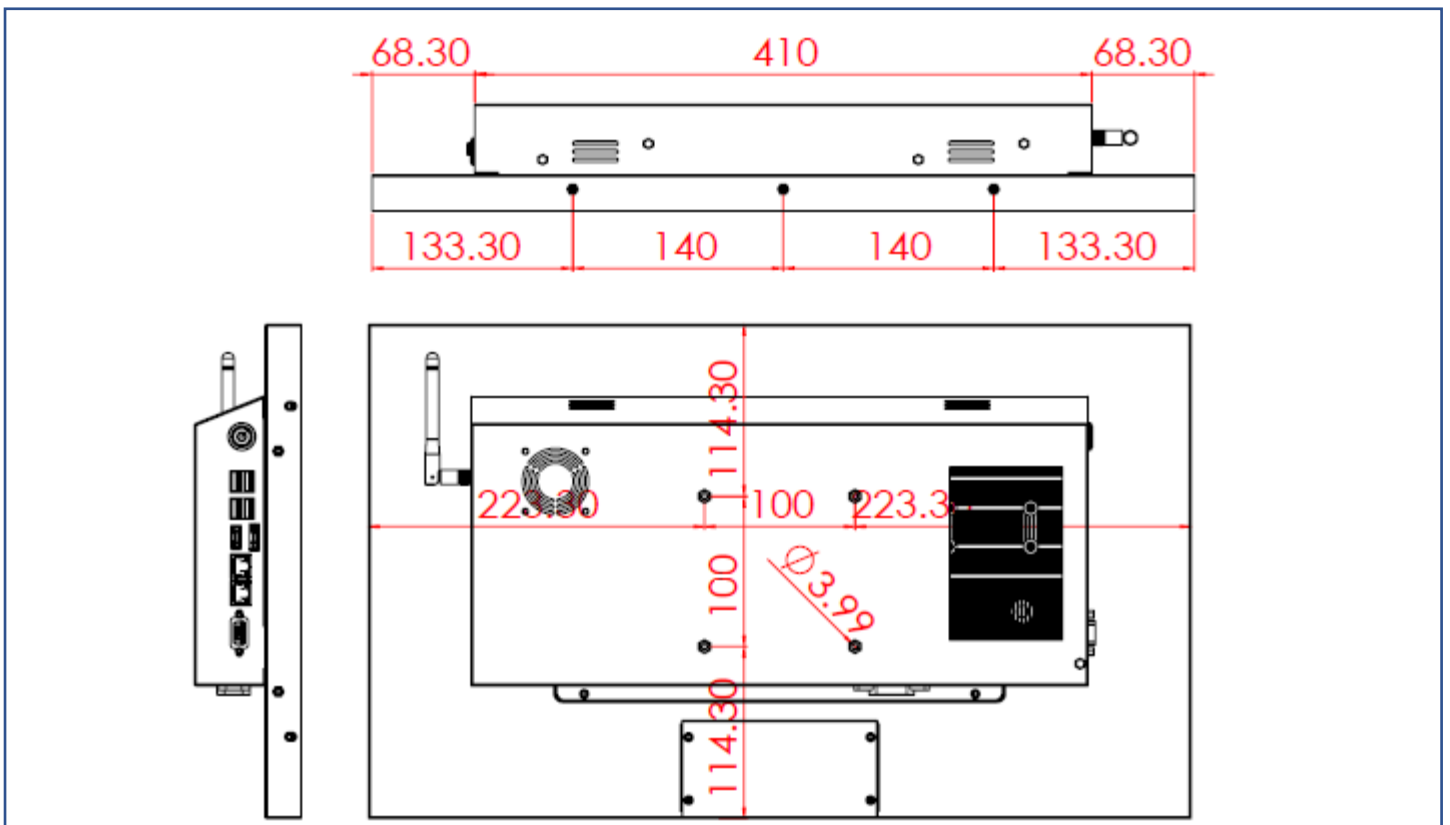
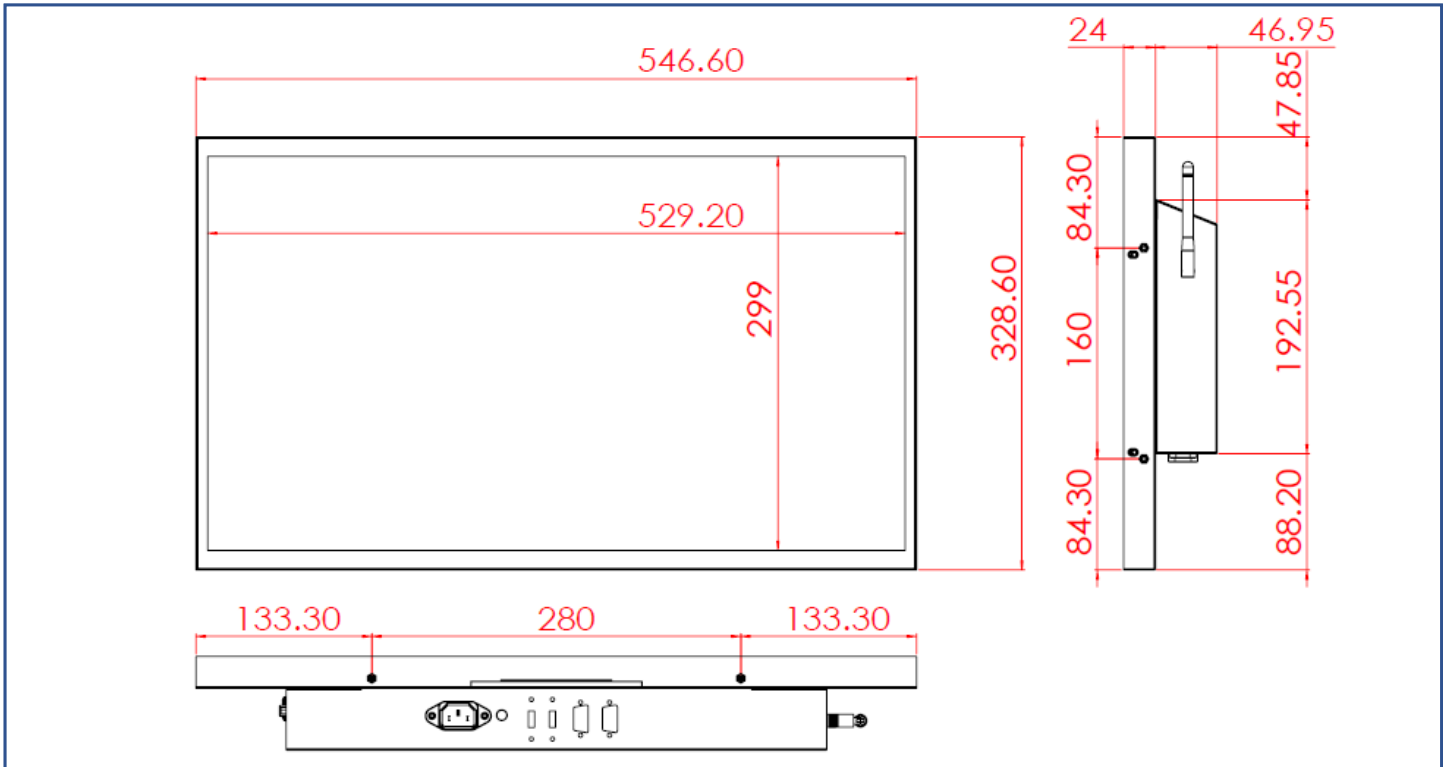

Cosmetic Inspection Standard

Display Area Allowance			
Defect description	Defective Specifications	Allowance	Remarks
Dot Defect (including dark dot, particles, bubbles, pits, dust, foreign matter)	$D \leq 0.2\text{mm}$	Ignored	D=Diameter
	$0.2 < D \leq 0.7\text{mm}$	$N \leq 5$	N=Quantity
	$0.7 < D \leq 1\text{mm}$	$N \leq 3$	
	$D > 1\text{mm}$	$N \leq 0$	
Linear Defect (including scratches, fluff, particles)	$W \leq 0.15\text{mm}$	Ignored	W=Width
	$0.15 < W \leq 0.5\text{mm}, L \leq 15\text{mm}$	$N \leq 2$	L=Length
	$W > 0.5\text{mm}$ or $L > 15\text{mm}$	NG	

* Visual inspection distance: 60cm, 90 degree (same for front/side/back)

Front Appearance Allowance (Including Coating)			
Defect description	Defective Specifications	Allowance	Remarks
Dot Defect (including particles, bubbles, pits...etc.)	$D \leq 0.7\text{mm}$	Ignored	D=Diameter
	$0.7 < D \leq 1.5\text{mm}$	$N \leq 3$	N=Quantity
	$D > 1.5\text{mm}$	$N \leq 0$	
Linear Defect (including scratches, fluff, particles)	$W \leq 0.2\text{mm}, L \leq 15\text{mm}$	Ignored	W=Width, L=Length
	$0.2 < W \leq 0.7\text{mm}, L \leq 15\text{mm}$	$N \leq 1$	
	$W > 0.7\text{mm}$ or $L > 15\text{mm}$	NG	

Side / Back Appearance Allowance (Including Coating)			
Defect description	Defective Specifications	Allowance	Remarks
Dot Defect (including particles, bubbles, pits...etc.)	$D \leq 1.5\text{mm}$	Ignored	D=Diameter
	$1.5 < D \leq 3\text{mm}$	$N \leq 8$	N=Quantity
	$D > 3\text{mm}$	$N \leq 2$	
Linear Defect (including scratches, fluff, particles)	$W \leq 0.8\text{mm}, L \leq 15\text{mm}$	Ignored	W=Width, L=Length
	$0.8 < W \leq 1.5\text{mm}, L \leq 15\text{mm}$	$N \leq 5$	
	$W > 1.5\text{mm}$ or $L > 15\text{mm}$	NG	

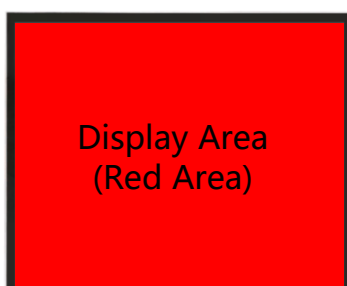

Display Area
(Red Area)



Front Appearance (Red Area)



Back Appearance