



Product Specifications

Customer	
Model Name	NTWP150-1 V511
Model Number	NTWP150<u>XXSXX</u>-GI<u>XXXXXX</u>-<u>XX</u>05-511

* X = A~Z, 0~9 (Depends on Options.)



Records of Revision			
Vision	Modifying	Old Description	New Description
v2209.1	Preliminary Specification		

Features

- ★ 15 inch Industrial Grade Panel, 1024x768 Resolution
- ★ Operating Temperature Range -30~70°C
- ★ Intel® 11th Generation Core i Series CPU
- ★ DDR4 8G RAM (Max. 64G)
- ★ Narrow Bezel, True Flat Projected Capacitive Touch Screen
- ★ 7H Hardness Tempered Cover Glass
- ★ 10 points Multi-touch, Supports Active Stylus
- ★ Metal Cabinet with Diverse Combine Options
- ★ Made in Taiwan, 3 Years Warranty, Designed for Harsh Environments
- ★ Optional High Brightness 1500nits, for Outdoor Environment
- ★ Optional AG Coating/Antibacterial/Privacy Filter Surface Treatment



Desktop Stand



Wall Mounting



Open-frame Bracket



Panel Mount



System Specifications

CPU	Intel® 11th Generation Core i Series CPU
Memory	DDR4 SO-DIMM x2, Max. 64G
Storage	Ultra-Fast M.2 with PCIe Gen3 x2, SATA 6Gb/s x1
GPU	Intel® UHD Graphics
Sound Chip	Realtek Audio CODEC
Network	Intel Gigabit LAN, RJ45 ports x2

Display Specifications

Screen Diagonal	15.0 inch	Display Mode	Normally Black
Display Area	304.1x228.1	Backlight Unit	LED (white LED)
Resolution	1024x768	Viewing Angle (L/R, U/D)	176°/176°
Contrast Ratio	2500:1	Backlight Lifetime	>70,000 Hours
Display Ratio	4:3	Operating Temp.	-30~70°C
Support Colors	16.7M Colors	Storage Temp.	-40~70°C
Pixel Pitch	297x297 um	Surface Treatment	Anti-glare, Hardness 3H
Response Time	21 msec.		

Display Options

Brightness			
	Brightness	Environment	Model Name
Standard	300nits	General (Indoor)	NTWP150NXSXX-GIXXXXX-XX05-511
Option 1	1000nits	Outdoor Environment	NTWP150ASXX-GIXXXXX-XX05-511
Option 2	1500nits	Sunlight Readable	NTWP150FXXSXX-GIXXXXX-XX05-511

Touch Options

Projected Capacitive			
Model Name	NTWP150 <u>P</u> <u>S</u> <u>X</u> <u>X</u> -G <u>I</u> <u>X</u> <u>X</u> <u>X</u> <u>X</u> <u>X</u> - <u>X</u> <u>X</u> 05-511		
Touch Technology	Projected Capacitive	Thickness of Cover Lens	2.0±0.2mm
Allowed Touch Points	10 points	Hardness of Cover Lens	7H
Transparency	≥87%	IK Ratings	IK07
Accuracy	99.00%		

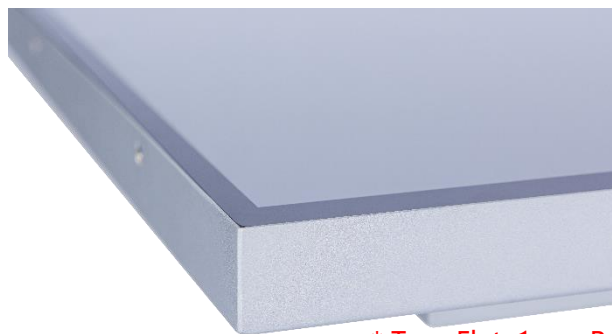

* True Flat, 1mm Bezel

Non-Touch	
Model Name	NTWP150 <u>X</u> <u>0</u> <u>S</u> <u>X</u> <u>X</u> -G <u>I</u> <u>X</u> <u>X</u> <u>X</u> <u>X</u> <u>X</u> - <u>X</u> <u>X</u> 05-511

Surface Treatment Options		
	Description	Model Name
Standard	(none)	NTWP150<u>X</u><u>X</u><u>S</u><u>00</u>-G<u>I</u><u>X</u><u>X</u><u>X</u><u>X</u><u>X</u>-<u>X</u><u>X</u>05-511
Option 1	Anti-Glare Coating	NTWP150 <u>X</u> <u>X</u> <u>S</u> <u>GG</u> -G <u>I</u> <u>X</u> <u>X</u> <u>X</u> <u>X</u> <u>X</u> - <u>X</u> <u>X</u> 05-511
Option 2	Antibacterial (AB Film)	NTWP150 <u>X</u> <u>X</u> <u>S</u> <u>AB</u> -G <u>I</u> <u>X</u> <u>X</u> <u>X</u> <u>X</u> <u>X</u> - <u>X</u> <u>X</u> 05-511
Option 3	Anti-Spy (AS Film)	NTWP150 <u>X</u> <u>X</u> <u>S</u> <u>SF</u> -G <u>I</u> <u>X</u> <u>X</u> <u>X</u> <u>X</u> <u>X</u> - <u>X</u> <u>X</u> 05-511



System Options

CPU		
	Item	Model Name
Standard	Intel® Core i3-1115G4E	NTWP150XXSXX-GI<u>31</u>XXX-XX05-511
Option 1	Intel® Core i5-1135G7	NTWP150XXSXX-GI <u>51</u> XXX-XX05-511
Option 2	Intel® Core i7-1165G7	NTWP150XXSXX-GI <u>71</u> XXX-XX05-511

Memory		
	Item	Model Name
Standard	DDR4 SO-DIMM 8G	NTWP150XXSXX-GIXX<u>8</u>XX-XX05-511
Option 1	DDR4 SO-DIMM 16G	NTWP150XXSXX-GIXX <u>A</u> XX-XX05-511
Option 2	DDR4 SO-DIMM 32G	NTWP150XXSXX-GIXX <u>B</u> XX-XX05-511
Option 3	DDR4 SO-DIMM 64G	NTWP150XXSXX-GIXX <u>C</u> XX-XX05-511

Storage		
	Item	Model Name
Standard	SSD 128G	NTWP150XXSXX-GIXXX<u>S1</u>-XX05-511
Option 1	SSD 256G	NTWP150XXSXX-GIXXX <u>S2</u> -XX05-511
Option 2	SSD 512G	NTWP150XXSXX-GIXXX <u>S3</u> -XX05-511
Option 3	SSD 1T	NTWP150XXSXX-GIXXX <u>S4</u> -XX05-511

System Options (Continued)

Material of Cabinet		
	Description	Model Name
Standard	SECC	NTWP150XXSXX-GIXXXXXX-<u>S</u>X05-511
Option 1	Stainless Steel	NTWP150XXSXX-GIXXXXXX- <u>L</u> X05-511
Option 2	Aluminum	NTWP150XXSXX-GIXXXXXX- <u>A</u> X05-511

Color of Cabinet		
	Description	Model Name
Standard	Silver	NTWP150XXSXX-GIXXXXXX-<u>X</u>S05-511
Option 1	White	NTWP150XXSXX-GIXXXXXX- <u>X</u> W05-511
Option 2	Black	NTWP150XXSXX-GIXXXXXX- <u>X</u> B05-511
Options	Other Colors	NTWP150XXSXX-GIXXXXXX- <u>X</u> X05-511

* X = A~Z, 0~9 (Depends on Color)

Other Options

Wireless Network (Option)	
Spec	Wi-Fi a/b/g/n/ac, Dual Mode Bluetooth 2.1/2.1+EDR,3.0,3.0+HS,4.0 (BLE) (Wi-Fi+BT4.0)

Active Stylus (Option)	
Technology	Active Capacitive Coupled
Working Frequencies	90~250 KHZ
Pressure Level	256~1024 Levels
Side Buttons	2 Side Buttons (Eraser, Barrel)
Active Tip Force	5~25g
Max. Tip Force	400g



Input /Output System

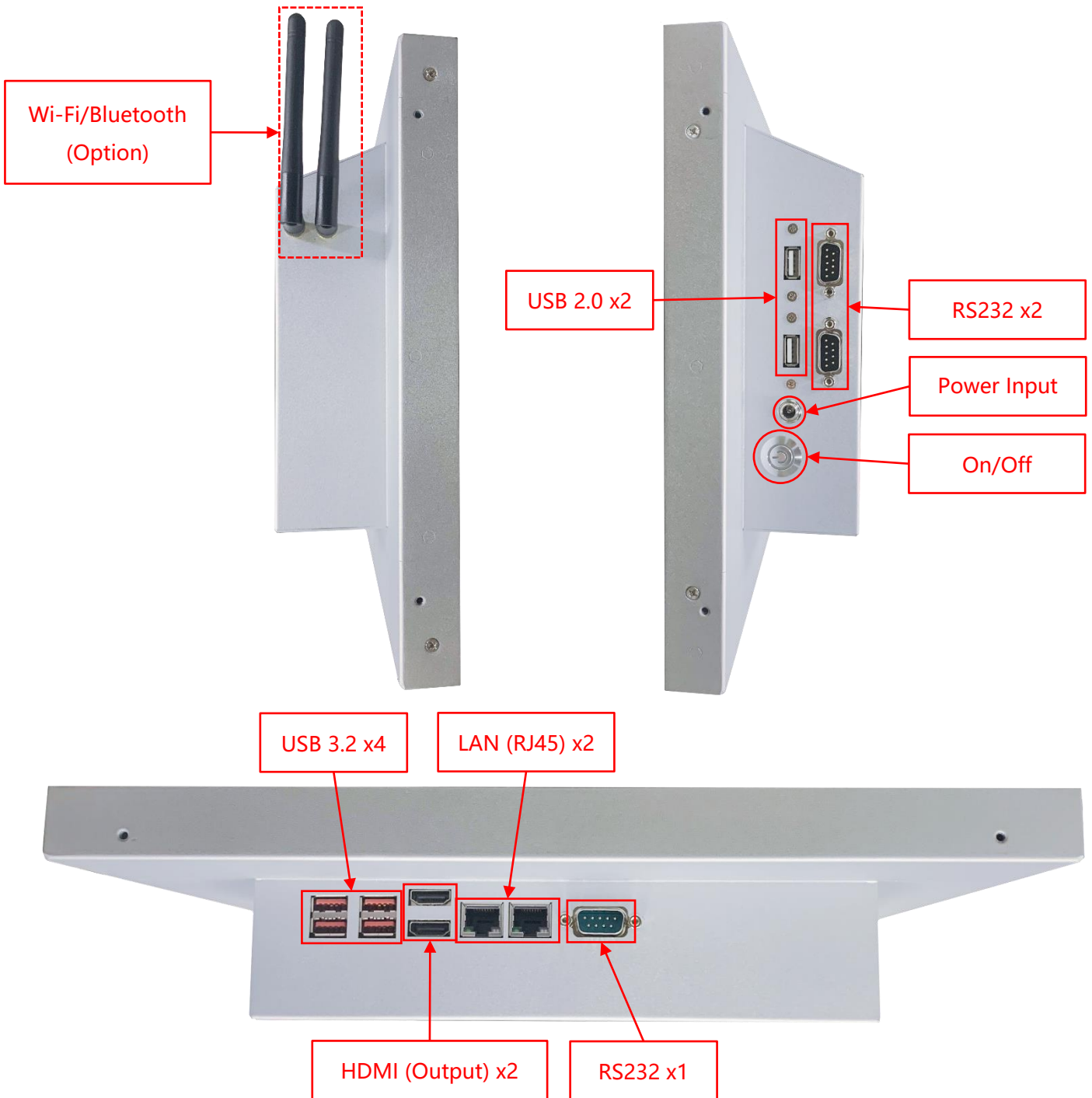

輸出/輸入	數量	輸出/輸入	數量
HDMI (輸出)	2	網路介面(RJ45)	2
USB 3.2 Gen2	4	喇叭	2W x2
USB 2.0	2	DC 電源輸入	1
RS232	3	WIFI/藍芽 及增益天線	選配

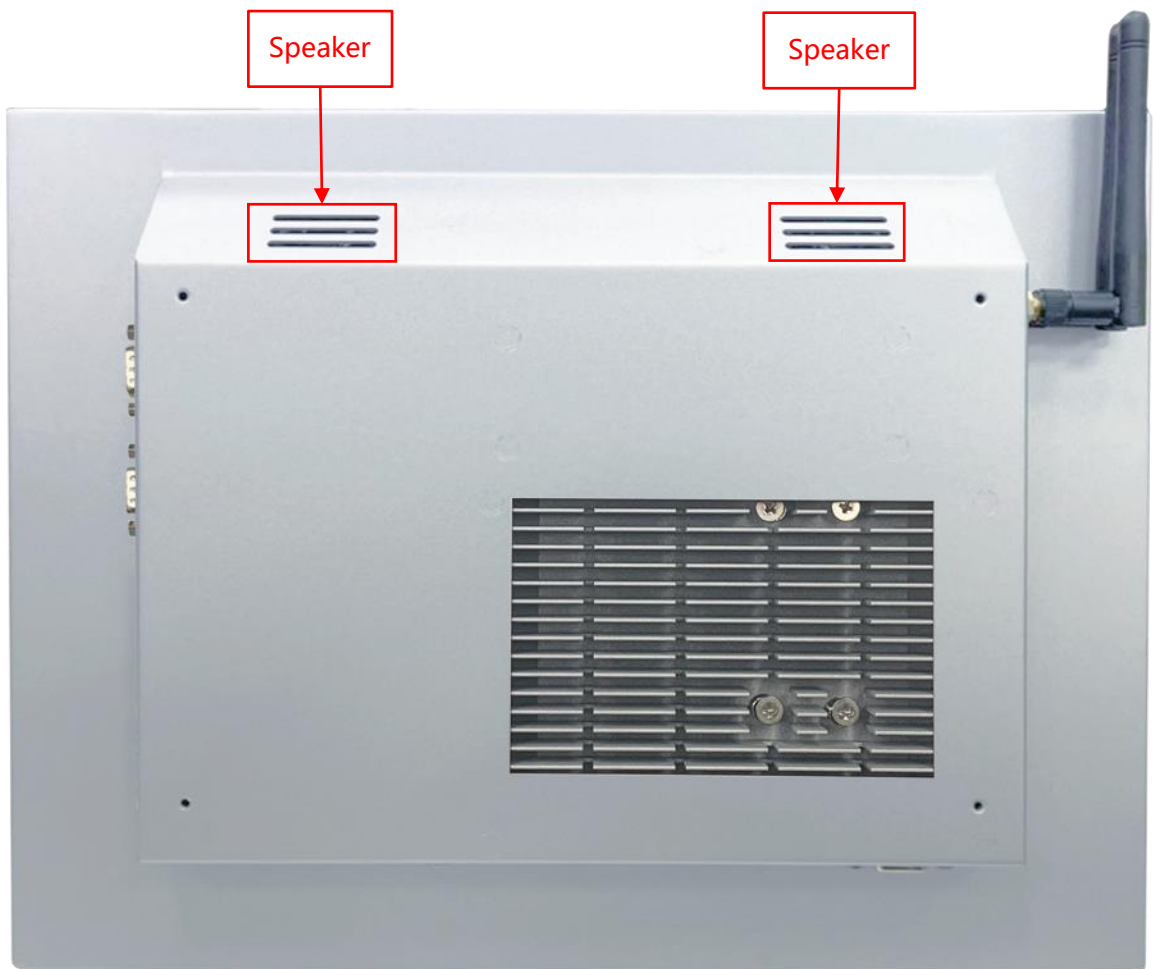

Mounting Plate (Option)

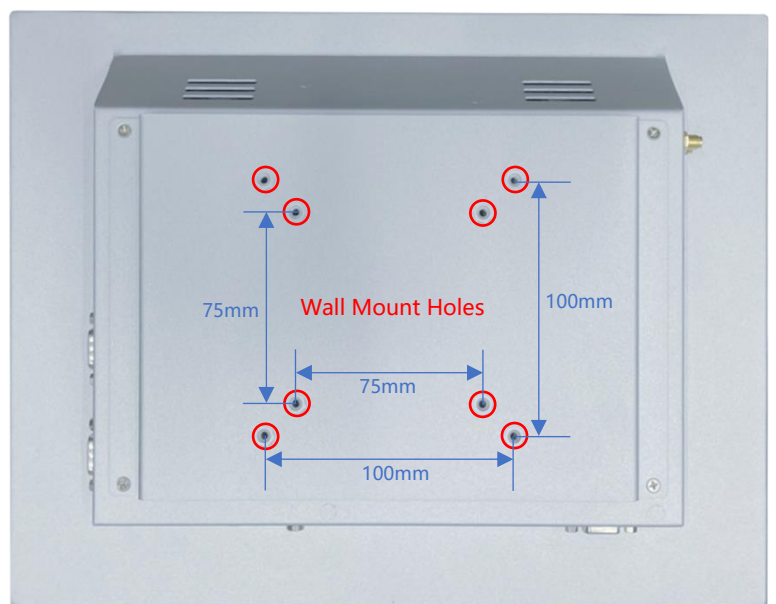

Front Cover (Option)

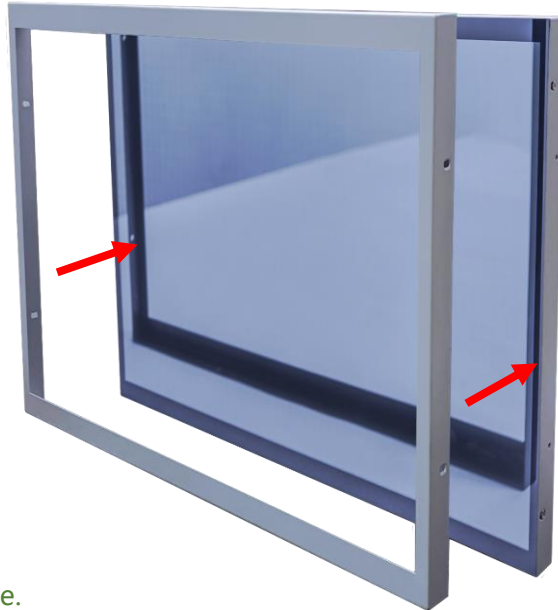

The standard **NTWP150** is true flat surface.

To protect the corners of the touch screen, the Front Cover can be added.



The watertight gasket can be added between the Front Cover and **NTWP150**.

It complies **IP65** on front.

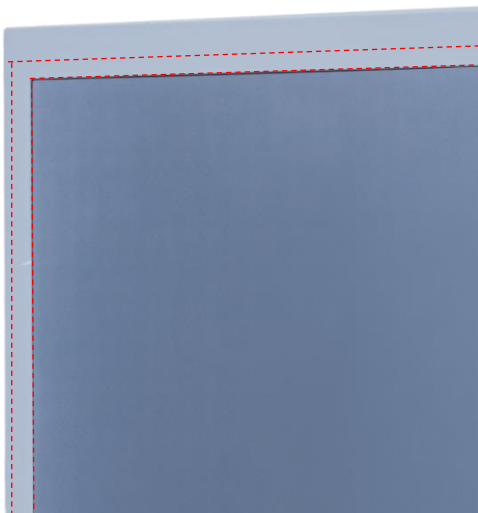

Open-frame Brackets (Option)

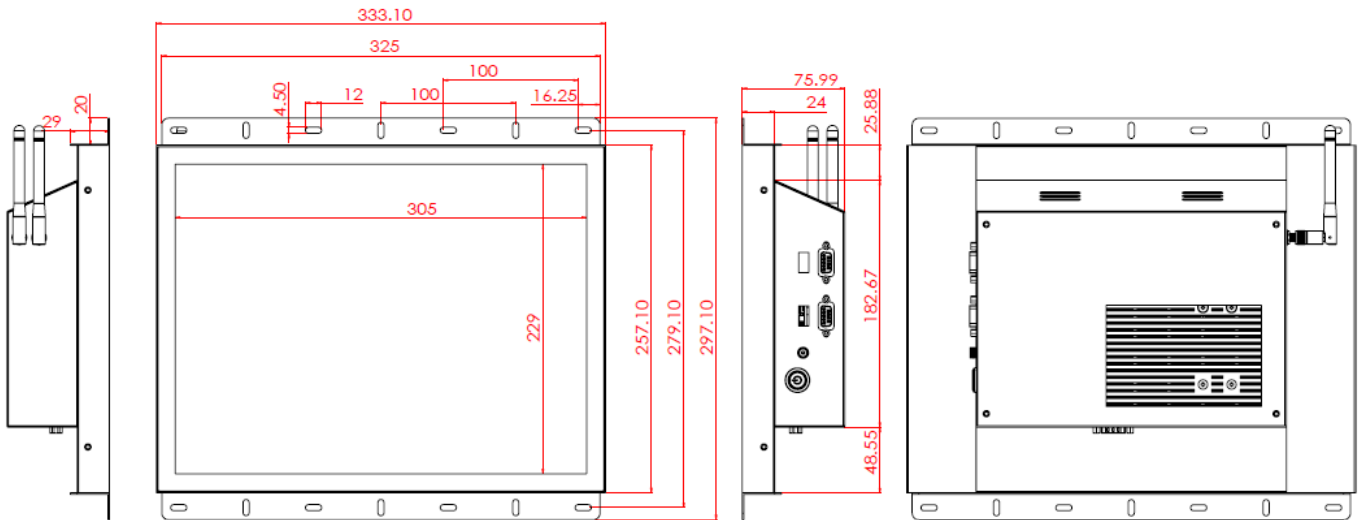
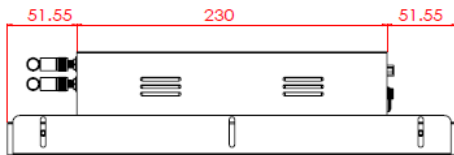
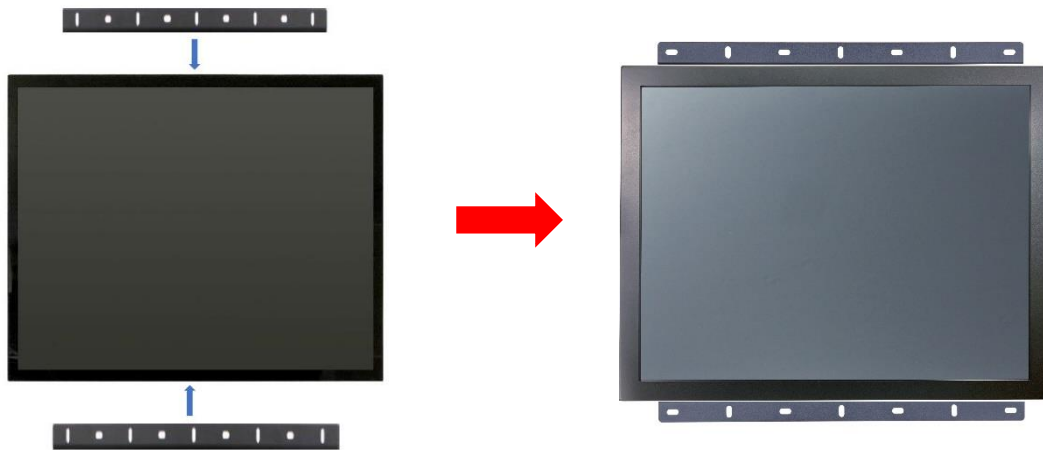

Panel Mount Kits (Option)

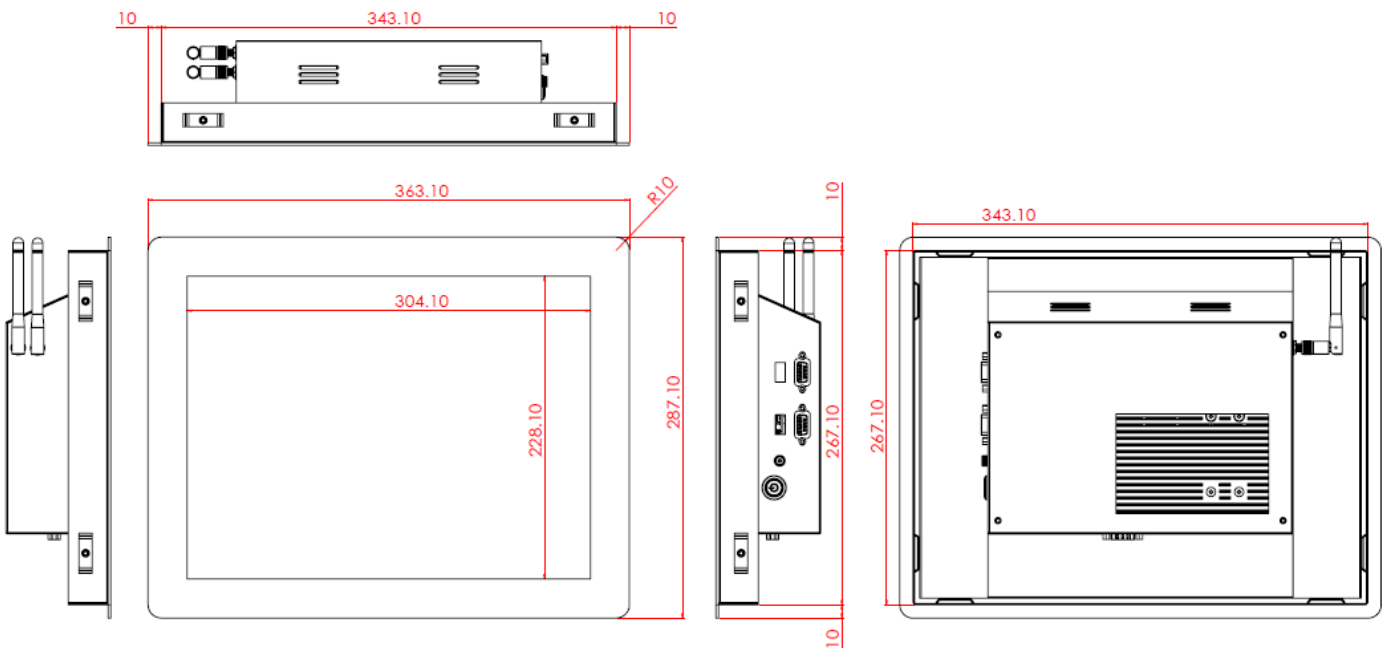

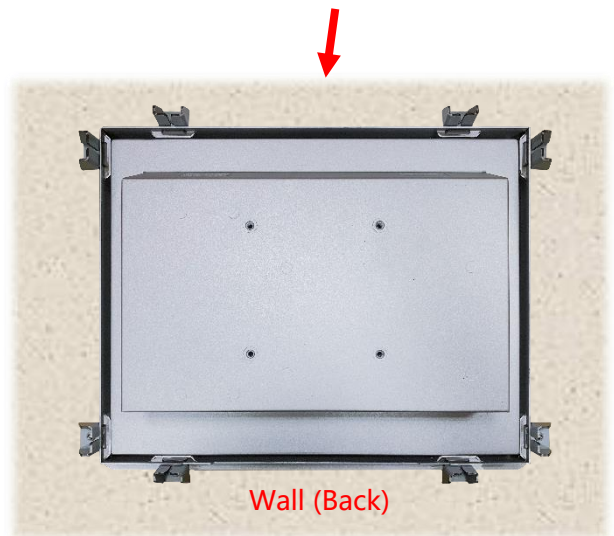
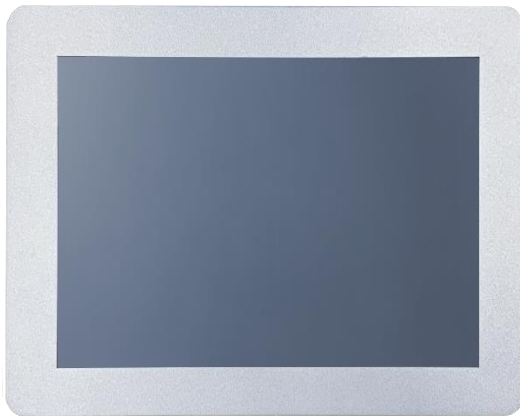
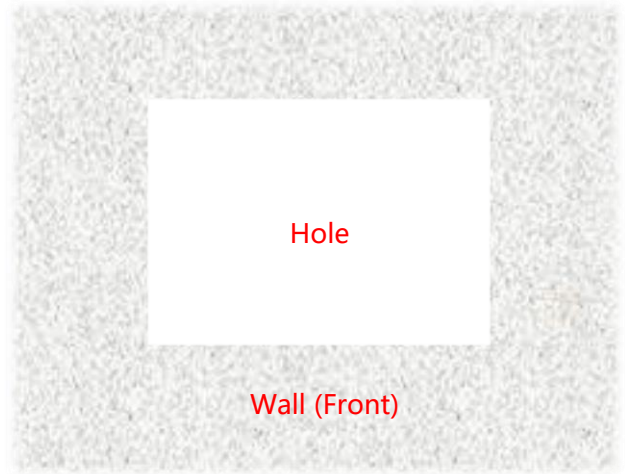
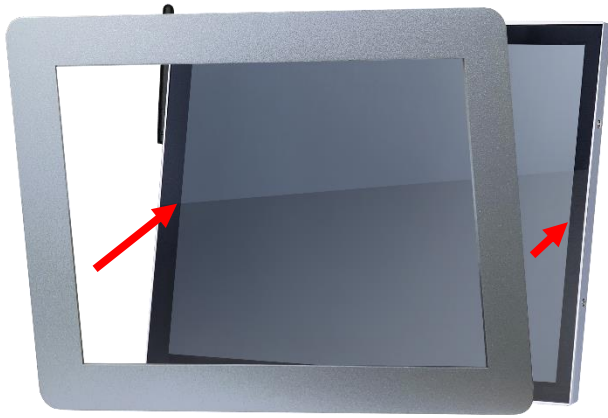

Desktop Stand (Option)

Item	L Stand	Part No.	DST-0B004/DST-1B004
Mounting Pattern	100x100 / 75x75 mm	Dimension (WxHxD)	194x194x222 mm
Material	SECC	Net Weight	1.4 KG
Tilt (Hinge)	105°	Support Max. Weight	15 KG

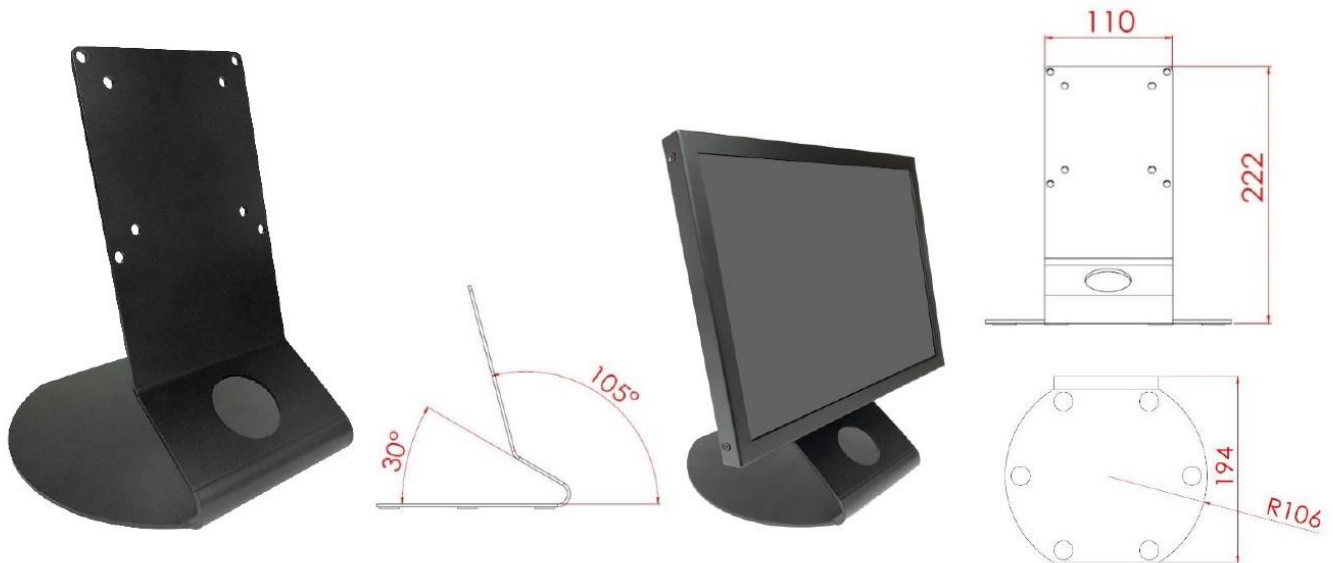

Item	B Stand	Part No.	DST-0B002/DST-1B002
Mounting Pattern	100x100 / 75x75 mm	Dimension (WxHxD)	203x275x227 mm
Material	Steel/Plastic/Aluminum	Net Weight	1.8 KG
Tilt (Hinge)	-2° ~ +180°	Support Max. Weight	15 KG



Wall Mount Bracket (Option)

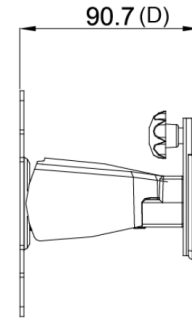
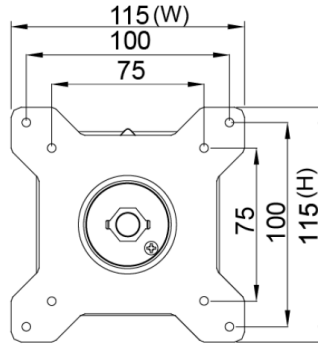
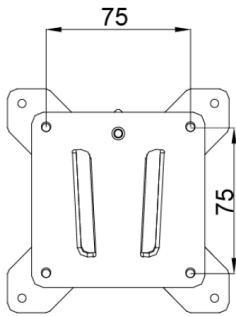
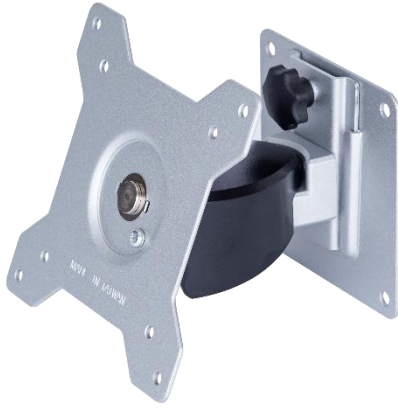

Packing Information

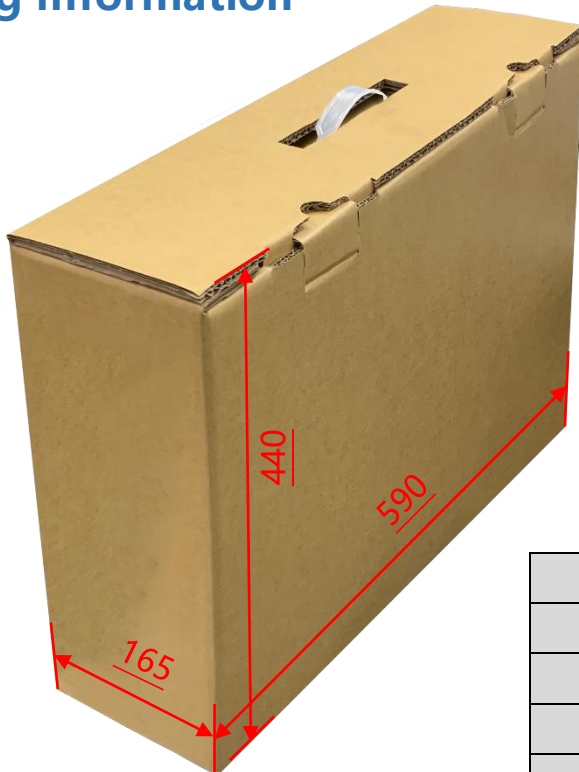

Unit Carton Size	590x165x440 mm
Unit N. Weight	≤3.2 KG
Unit G. Weight	≤5.0 KG
Units per Pallet	36 units
Pallet Size	120x100x147 CM

Physical Specifications (TBD)

Dimension	333x257x76(±2)mm (W/O Antenna)	Net Weight	≤3.2 KG
-----------	---------------------------------------	------------	----------------

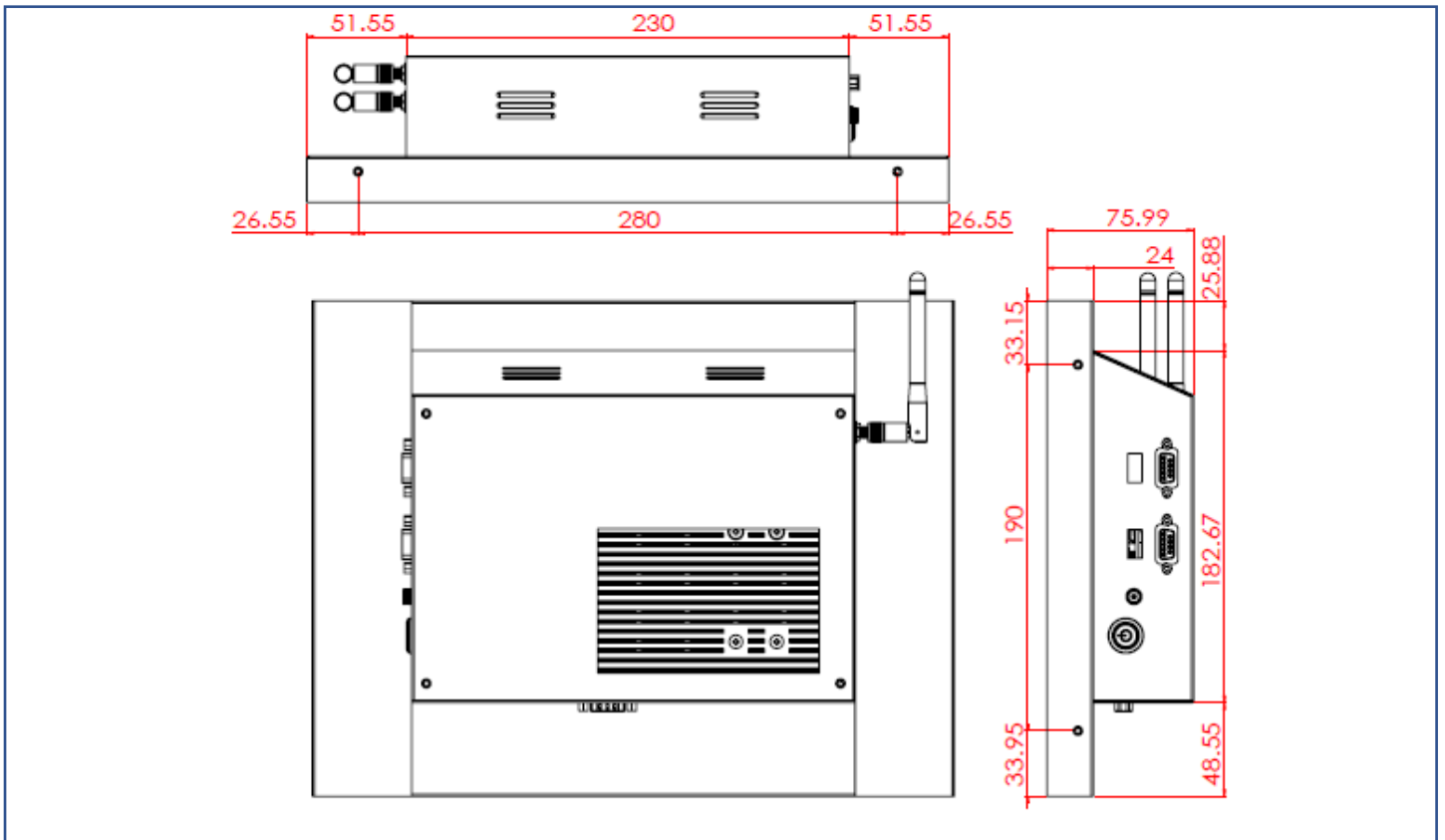
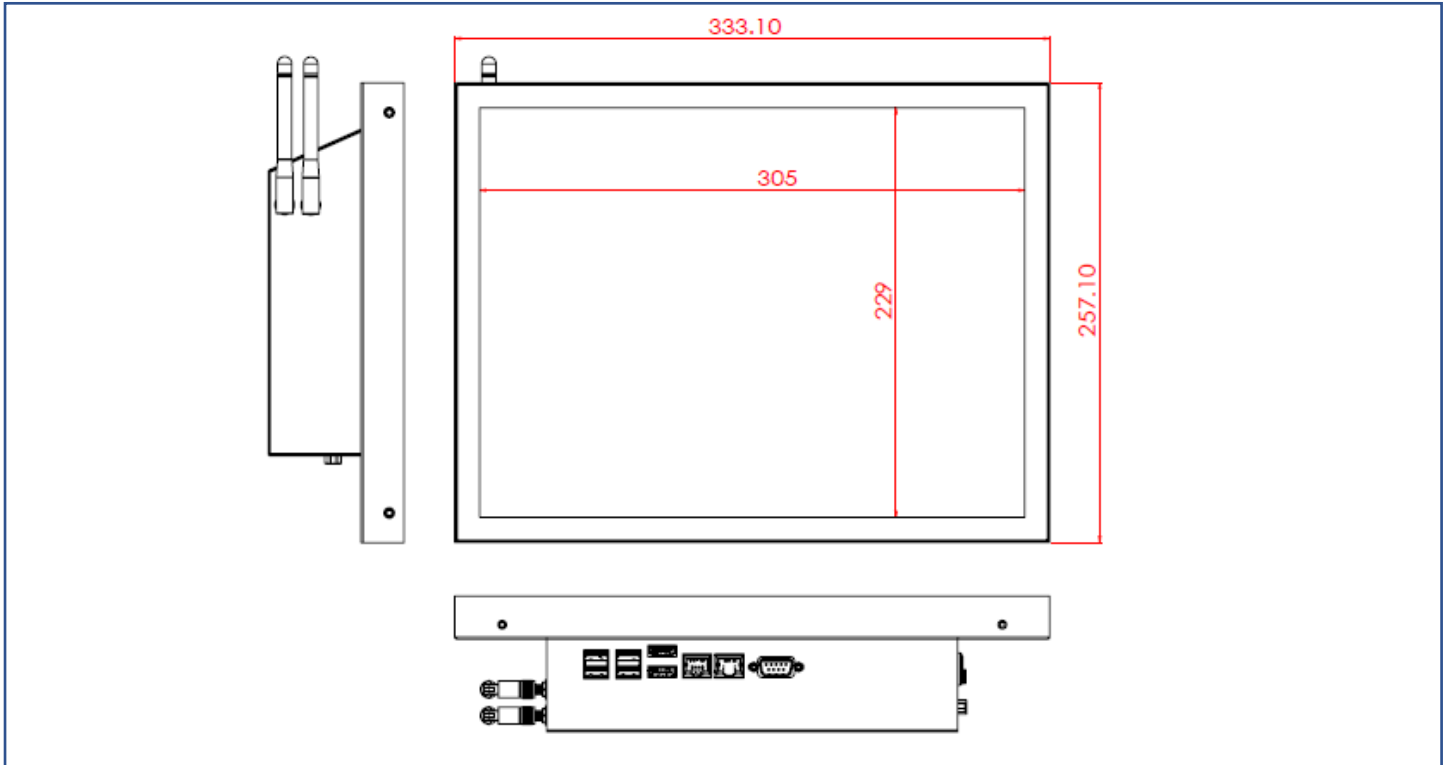

Cosmetic Inspection Standard

Display Area Allowance			
Defect description	Defective Specifications	Allowance	Remarks
Dot Defect (including dark dot, particles, bubbles, pits, dust, foreign matter)	$D \leq 0.2\text{mm}$	Ignored	D=Diameter
	$0.2 < D \leq 0.7\text{mm}$	$N \leq 5$	N=Quantity
	$0.7 < D \leq 1\text{mm}$	$N \leq 3$	
	$D > 1\text{mm}$	$N \leq 0$	
Linear Defect (including scratches, fluff, particles)	$W \leq 0.15\text{mm}$	Ignored	W=Width
	$0.15 < W \leq 0.5\text{mm}, L \leq 15\text{mm}$	$N \leq 2$	L=Length
	$W > 0.5\text{mm}$ or $L > 15\text{mm}$	NG	

* Visual inspection distance: 60cm, 90 degree (same for front/side/back)

Front Appearance Allowance (Including Coating)			
Defect description	Defective Specifications	Allowance	Remarks
Dot Defect (including particles, bubbles, pits...etc.)	$D \leq 0.7\text{mm}$	Ignored	D=Diameter
	$0.7 < D \leq 1.5\text{mm}$	$N \leq 3$	N=Quantity
	$D > 1.5\text{mm}$	$N \leq 0$	
Linear Defect (including scratches, fluff, particles)	$W \leq 0.2\text{mm}, L \leq 15\text{mm}$	Ignored	W=Width, L=Length
	$0.2 < W \leq 0.7\text{mm}, L \leq 15\text{mm}$	$N \leq 1$	
	$W > 0.7\text{mm}$ or $L > 15\text{mm}$	NG	

Side / Back Appearance Allowance (Including Coating)			
Defect description	Defective Specifications	Allowance	Remarks
Dot Defect (including particles, bubbles, pits...etc.)	$D \leq 1.5\text{mm}$	Ignored	D=Diameter
	$1.5 < D \leq 3\text{mm}$	$N \leq 8$	N=Quantity
	$D > 3\text{mm}$	$N \leq 2$	
Linear Defect (including scratches, fluff, particles)	$W \leq 0.8\text{mm}, L \leq 15\text{mm}$	Ignored	W=Width, L=Length
	$0.8 < W \leq 1.5\text{mm}, L \leq 15\text{mm}$	$N \leq 5$	
	$W > 1.5\text{mm}$ or $L > 15\text{mm}$	NG	



Display Area
(Red Area)



Front Appearance (Red Area)



Back Appearance