

Product Specifications

Customer	
Model Name	NTWP156-4 V502E
Model Number	NTWP156H<u>X</u>4<u>XX</u>-GI<u>XX</u>8<u>XX</u>-<u>XX</u>F4-502E

* X = A~Z, 0~9 (Depends on Options.)



Records of Revision			
Vision	Modifying	Old Description	New Description
v2407.1	Preliminary Specification		

Features

- ★ 15.6 inch Wide Industrial Grade Panel, 1920x1080(FHD) Resolution
- ★ AHVA Wide Viewing Angle Technology (178°/178°)
- ★ 1000nits High Brightness
- ★ Operating Temperature Range -30~85°C
- ★ Intel® Quad-Core N3350/N4200 CPU
- ★ DDR3 8G DRAM
- ★ Narrow Bezel, True Flat Projected Capacitive Touch Screen
- ★ UV-protective, 7H Hardness Tempered Cover Glass
- ★ 10 points Multi-touch, Supports NEXTECH Dedicated Stylus
- ★ Metal Cabinet with Diverse Combine Options
- ★ Made in Taiwan, 3 Years Warranty, Designed for Harsh Environments
- ★ Optional Anti-Glare&UV/Antibacterial/Privacy Filter Surface Treatment



Desktop Stand



Wall Mounting



Open-frame Bracket



Panel Mount

System Specifications

CPU	Intel® Celeron/Pentium Processor
Memory	DDR3 SO-DIMM 8G
Storage	SATAx1, M.2 M-key (SATA 6Gb/s) x1, Full-size Mini PCIe Slot x1
GPU	Intel® HD Graphics 500
Sound Chip	Realtek® Audio CODEC
Network	Intel® i211AT Gbe LAN Chips x2

Display Specifications

Screen Diagonal	15.6 inch	Display Mode	AHVA Mode, Normally Black
Display Area	344.2x193.6 mm	Backlight Unit	LED (white LED)
Resolution	1920x1080 (FHD)	Viewing Angle (L/R, U/D)	178°/178° (CR=10)
Contrast Ratio	1000:1	Response Time	25 msec.
Display Ratio	16:9	Backlight Lifetime	>50,000 Hours
Support Colors	16.7M Colors	Operating Temp.	-30~85°C
Pixel Pitch	0.17925x0.17925 mm	Storage Temp.	-30~85°C
Brightness	1000nits		

Touch Options

Touch Screen		
	Description	Model Name
Standard	Projected Capacitive Touch	NTWP156HP4XX-GIXX8XX-XXF4-502E
Option 1	Resistive Touch	NTWP156H54XX-GIXX8XX-XXF4-502E
Option 2	Non-Touch	NTWP156H04XX-GIXX8XX-XXF4-502E

Projected Capacitive

Touch Technology	Projected Capacitive	Thickness of Cover Lens	2.0±0.2mm
Allowed Touch Points	10 points	Hardness of Cover Lens	7H
Transparency	≥87%	IK Ratings	IK07
Accuracy	99.00%		

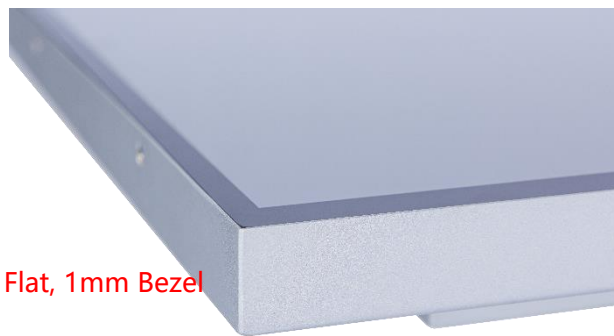

* True Flat, 1mm Bezel

Resistive Touch

Touch Technology	Resistive Touch	Transparency	80%±5%
Allowed Touch Points	1 point	Surface Treatment	Anti-glare<15%
Precision	98.50%	Hardness	≥3H

Surface Treatment		
	Description	Model Name
Standard	(none)	NTWP156HX400-GIXX8XX-XXF4-502E
Option 1	Anti-Glare&UV Coating	NTWP156HX4GG-GIXX8XX-XXF4-502E
Option 2	Antibacterial (AB Film)	NTWP156HX4AB-GIXX8XX-XXF4-502E
Option 3	Anti-Spy (AS Film)	NTWP156HX4SF-GIXX8XX-XXF4-502E

System Options

CPU		
	Item	Model Name
Standard	N3350	NTWP156HX4XX-GIC18XX-XXF4-502E
Option	N4200	NTWP156HX4XX-GIC28XX-XXF4-502E

Storage		
	Item	Model Name
Standard	SSD 128G	NTWP156HX4XX-GIXX8S1-XXF4-502E
Option 1	SSD 256G	NTWP156HX4XX-GIXX8S2-XXF4-502E
Option 2	SSD 512G	NTWP156HX4XX-GIXX8S3-XXF4-502E
Option 3	SSD 1TB	NTWP156HX4XX-GIXX8S4-XXF4-502E

Material of Cabinet		
	Description	Model Name
Standard	SECC	NTWP156HX4XX-GIXX8XX-SXF4-502E
Option 1	Stainless Steel	NTWP156HX4XX-GIXX8XX-LXF4-502E
Option 2	Aluminum	NTWP156HX4XX-GIXX8XX-AXF4-502E

Color of Cabinet		
	Description	Model Name
Standard	Silver	NTWP156HX4XX-GIXX8XX-XSF4-502E
Option 1	White	NTWP156HX4XX-GIXX8XX-XWF4-502E
Option 2	Black	NTWP156HX4XX-GIXX8XX-XBF4-502E
Options	Other Colors	NTWP156HX4XX-GIXX8XX-XXF4-502E

* X = A~Z, 0~9 (Depends on Color)

Passive Stylus Pen (Option)	
Technology	Passive High Sensitive Knitted Wire Mesh Fiber Tip
Size of tip	6mm
Magnetic Attachment	Yes

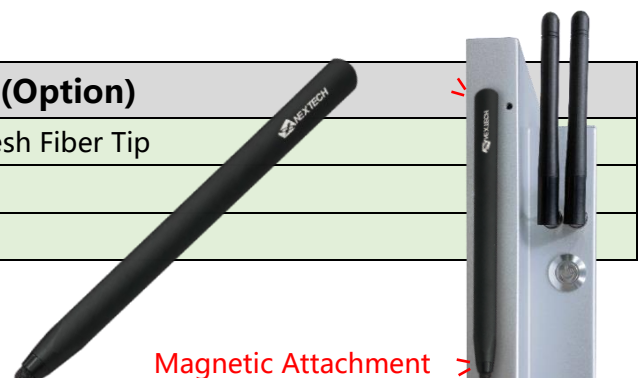

Magnetic Attachment >

Input /Output System

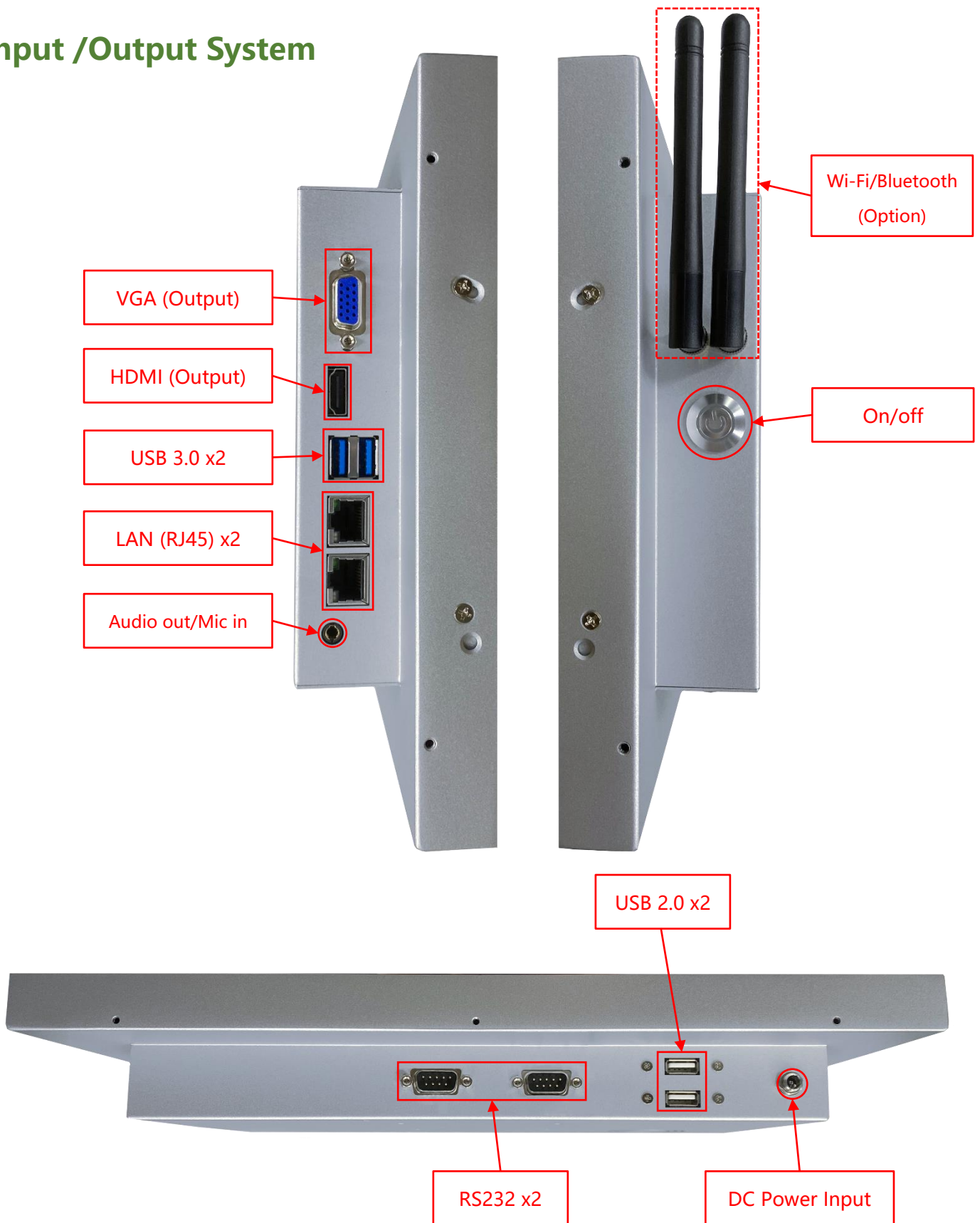

Nextech WP Series 15.6" All-in-one Industrial Touch PC

NTWP156-4 V502E

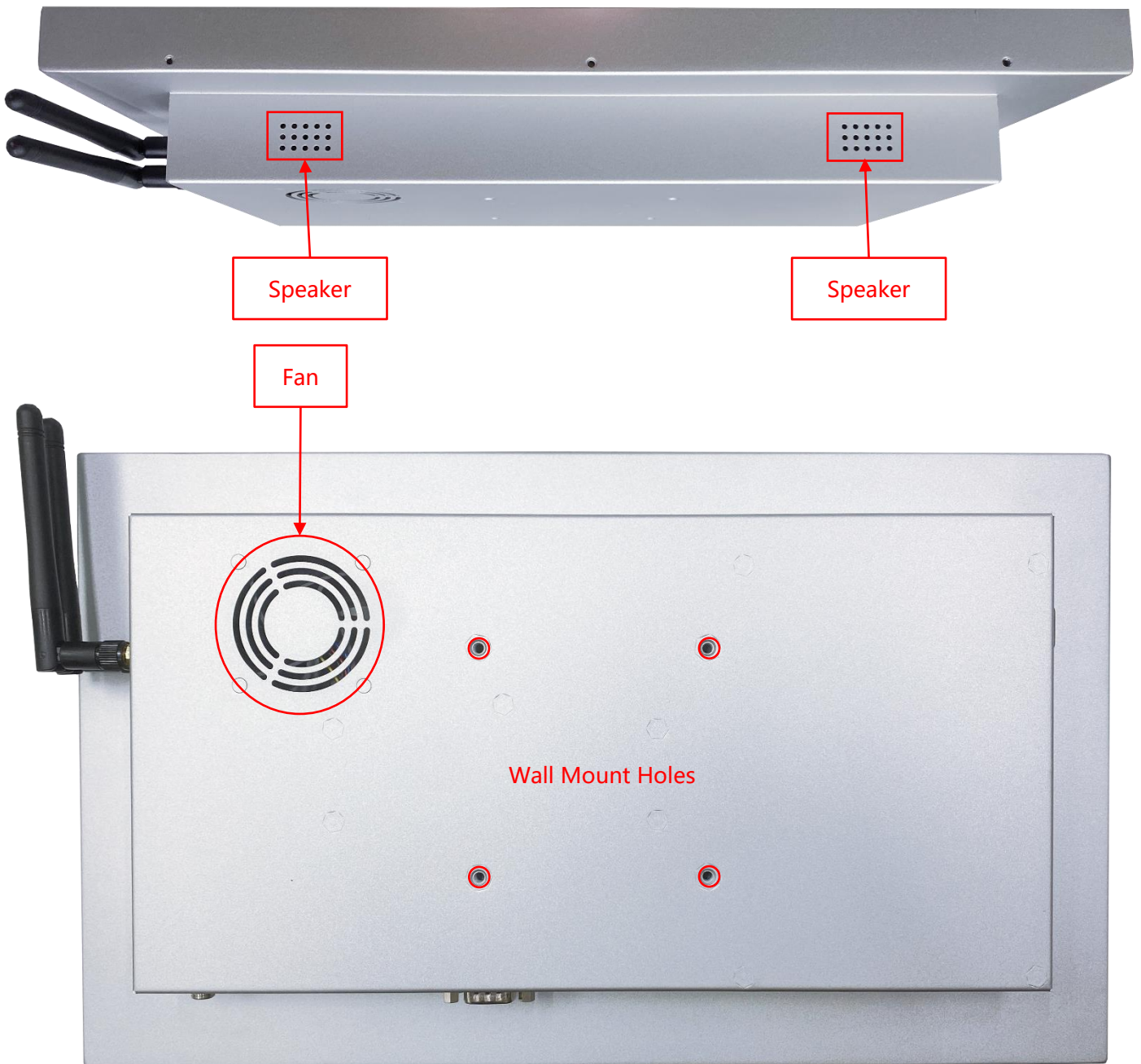

Input / Output	Connectors	Input / Output	Connectors
HDMI (Output)	1	USB 3.0	2
VGA (Output)	1	USB 2.0	2
Audio Output /Mic Input (3.5mm)	1	RS232	2
DC Power Input	1	LAN (RJ45)	2
Speakers	1W x2	Wi-Fi/Bluetooth & Antenna	Option

Front Cover (Option)

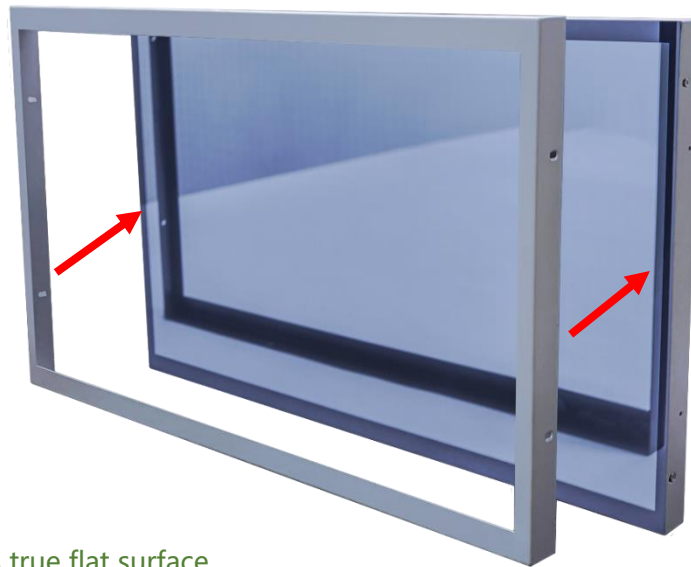

The standard **NTWP156** is true flat surface.

To protect the corners of the touch screen, the Front Cover can be added.



The watertight gasket can be added between the Front Cover and **NTWP156**.

It complies **IP65** on front.

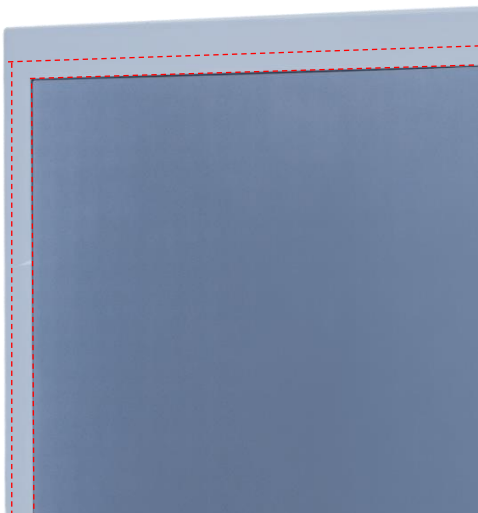

Panel Mount Kits (Option)



Dimension for Installing with Panel Mount Kit

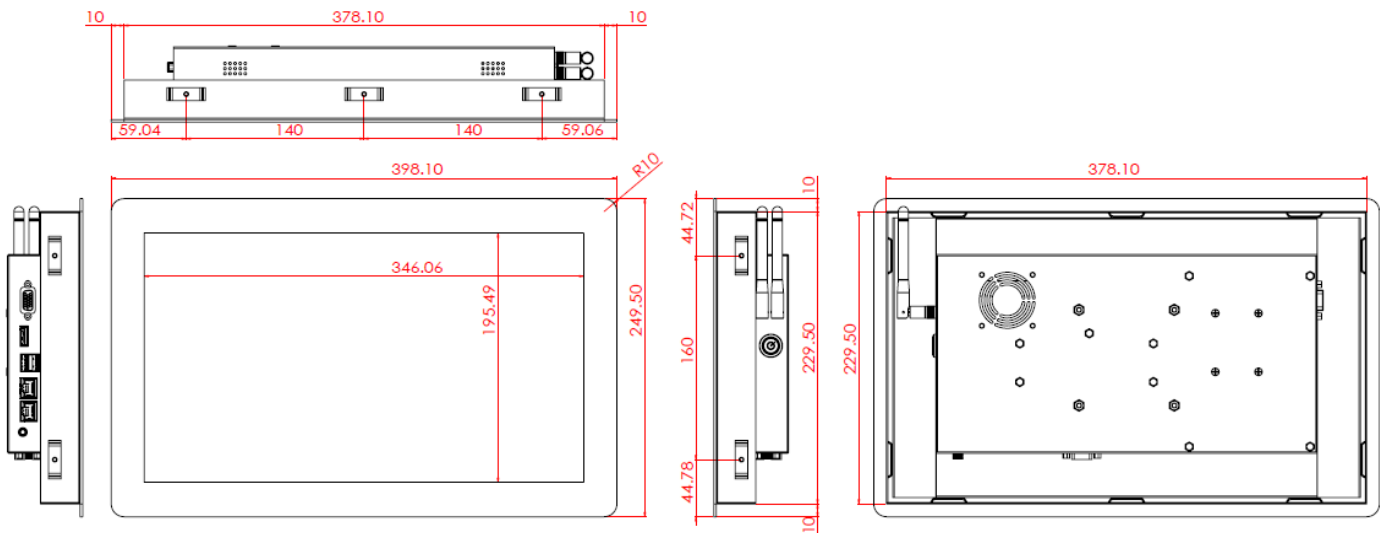

Nextech WP Series 15.6" All-in-one Industrial Touch PC

NTWP156-4 V502E

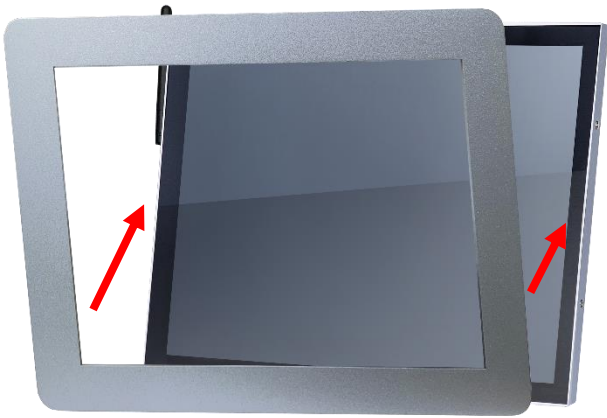

Step 1: Assemble the front module with the screen body. (This step is pre-assembled at the factory.)

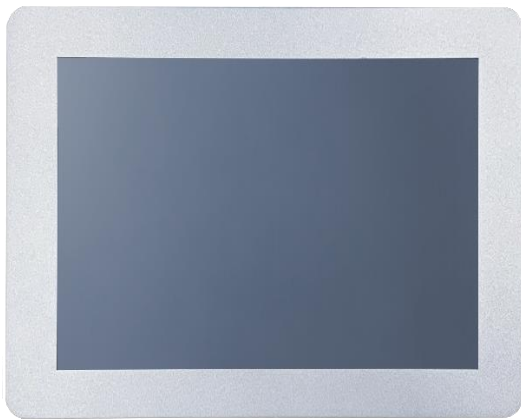
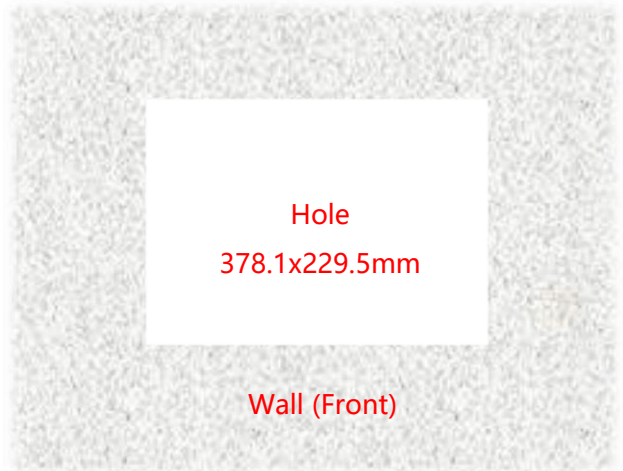

Step 2: Insert the screen from the front into the pre-cut opening.

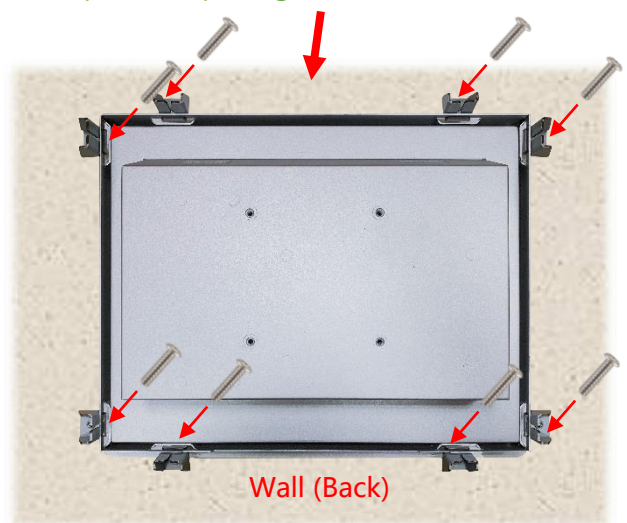

Step 3: Attach the clips from the back and secure with screws. (Up to 10 clips can be installed as needed or per positional limitations.)

Nextech WP Series 15.6" All-in-one Industrial Touch PC

NTWP156-4 V502E

Desktop Stand (Option)

Item	L Stand	Part No.	DST-0B004/DST-1B004
Mounting Pattern	100x100 / 75x75 mm	Dimension (WxHxD)	194x194x222 mm
Material	SECC	Net Weight	1.4 KG
Tilt (Hinge)	105°	Support Max. Weight	15 KG

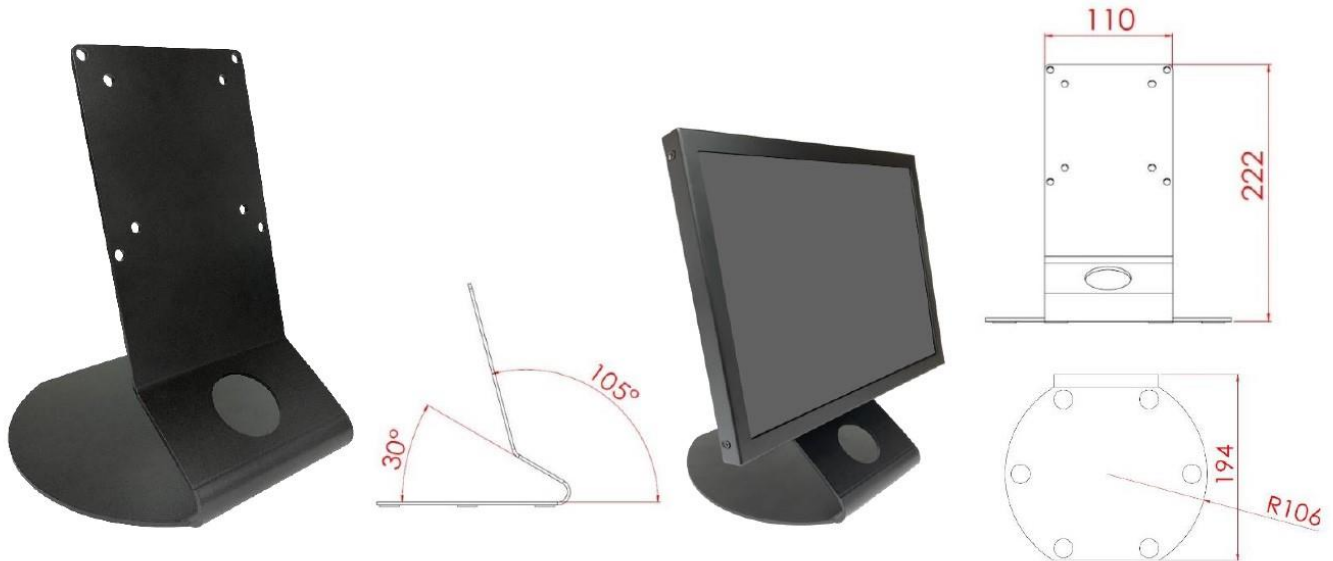

Item	B Stand	Part No.	DST-0B002/DST-1B002
Mounting Pattern	100x100 / 75x75 mm	Dimension (WxHxD)	203x275x227 mm
Material	Steel/Plastic/Aluminum	Net Weight	1.8 KG
Tilt (Hinge)	-2° ~ +180°	Support Max. Weight	15 KG



Wall Mount Bracket (Option)

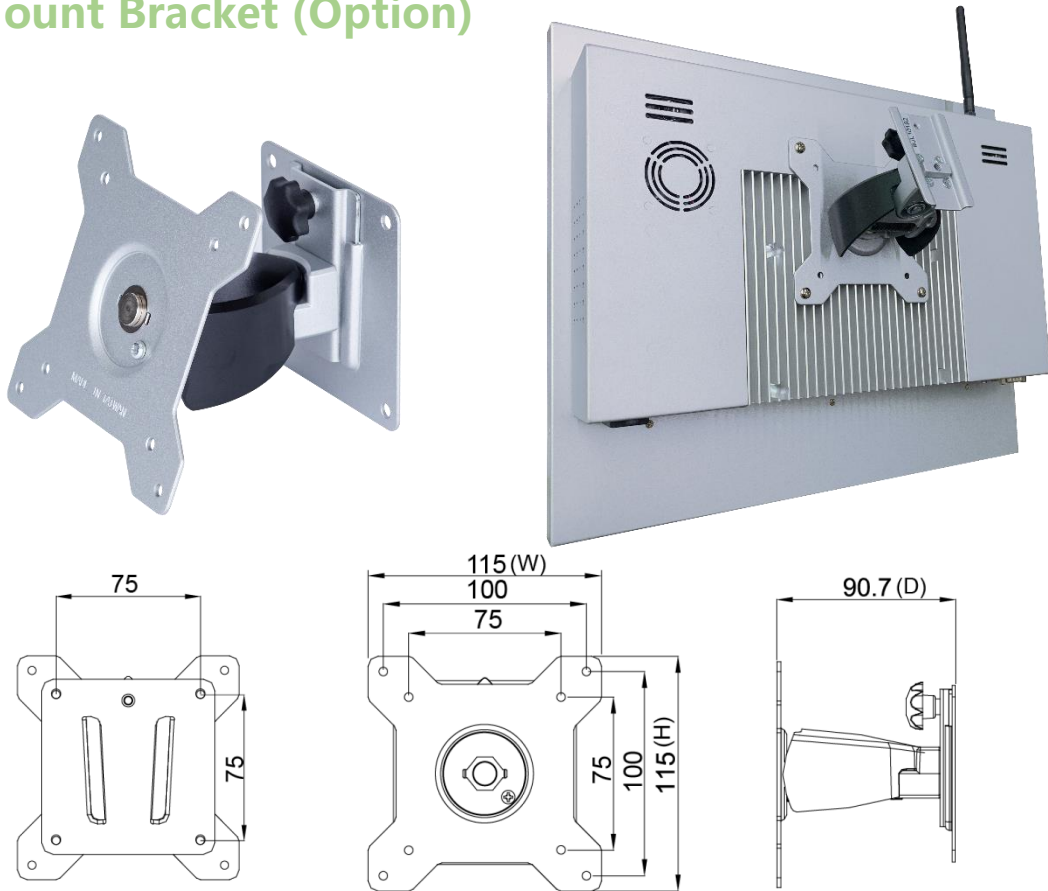

Packing Information

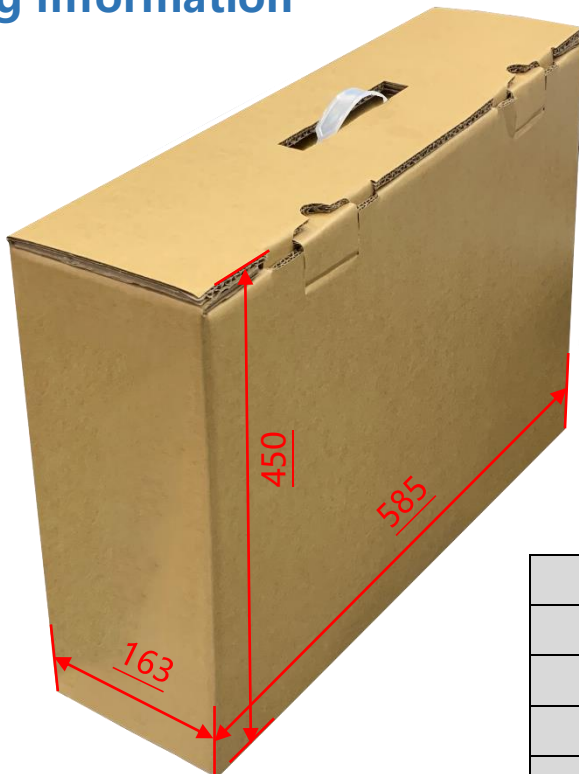

Unit Carton Size	585x163x450 mm
Unit N. Weight	≤3.2 KG
Unit G. Weight	≤5.0 KG
Units per Pallet	36 units
Pallet Size	120x100x147 CM

Cosmetic Inspection Standard

Display Area Allowance			
Defect description	Defective Specifications	Allowance	Remarks
Dot Defect (including dark dot, particles, bubbles, pits, dust, foreign matter)	$D \leq 0.2\text{mm}$	Ignored	D=Diameter
	$0.2 < D \leq 0.7\text{mm}$	$N \leq 5$	N=Quantity
	$0.7 < D \leq 1\text{mm}$	$N \leq 3$	
	$D > 1\text{mm}$	$N \leq 0$	
Linear Defect (including scratches, fluff, particles)	$W \leq 0.15\text{mm}$	Ignored	W=Width
	$0.15 < W \leq 0.5\text{mm}, L \leq 15\text{mm}$	$N \leq 2$	L=Length
	$W > 0.5\text{mm}$ or $L > 15\text{mm}$	NG	

* Visual inspection distance: 60cm, 90 degree (same for front/side/back)

Front Appearance Allowance (Including Coating)			
Defect description	Defective Specifications	Allowance	Remarks
Dot Defect (including particles, bubbles, pits...etc.)	$D \leq 0.7\text{mm}$	Ignored	D=Diameter
	$0.7 < D \leq 1.5\text{mm}$	$N \leq 3$	N=Quantity
	$D > 1.5\text{mm}$	$N \leq 0$	
Linear Defect (including scratches, fluff, particles)	$W \leq 0.2\text{mm}, L \leq 15\text{mm}$	Ignored	W=Width, L=Length
	$0.2 < W \leq 0.7\text{mm}, L \leq 15\text{mm}$	$N \leq 1$	
	$W > 0.7\text{mm}$ or $L > 15\text{mm}$	NG	

Side / Back Appearance Allowance (Including Coating)			
Defect description	Defective Specifications	Allowance	Remarks
Dot Defect (including particles, bubbles, pits...etc.)	$D \leq 1.5\text{mm}$	Ignored	D=Diameter
	$1.5 < D \leq 3\text{mm}$	$N \leq 8$	N=Quantity
	$D > 3\text{mm}$	$N \leq 2$	
Linear Defect (including scratches, fluff, particles)	$W \leq 0.8\text{mm}, L \leq 15\text{mm}$	Ignored	W=Width, L=Length
	$0.8 < W \leq 1.5\text{mm}, L \leq 15\text{mm}$	$N \leq 5$	
	$W > 1.5\text{mm}$ or $L > 15\text{mm}$	NG	



Display Area
(Red Area)



Front Appearance (Red Area)



Back Appearance