

Product Specifications

Customer	
Model Name	NTWP320-4 V612E
Model Number	NTWP320H <u>X</u> 4 <u>XX</u> -SI97 <u>XXX</u> - <u>XX</u> FA-612E

* X = A~Z, 0~9 (Depends on Options.)



Records of Revision			
Vision	Modifying	Old Description	New Description
v2512.1	Preliminary Specification		

Nextech WP Series 32" Industrial All-in-one Touch PC

NTWP320-4 V612E

Features

- ★ 32 inch, 1920x1080 (FHD) Resolution
- ★ 2500nits High Brightness
- ★ Wide Operating Temperature Range -20~60°C
- ★ Wide Viewing Angle (178°/178°)
- ★ Intel® Alder Lake N97 CPU
- ★ DDR4 8G RAM, Max to 16G
- ★ GbE LAN Port x2
- ★ 128G SSD, Max to 1T
- ★ HDMI Output x1, DP output x1
- ★ Realtek Audio HAD Codec,
- ★ RS485 Port x1, RS232 Port x6
- ★ USB 3.0 x4, USB 2.0 x3
- ★ Narrow Bezel, True Flat Projected Capacitive Touch Screen
- ★ 7H Hardness Tempered Cover Glass
- ★ 10 points Multi-touch, Supports NEXTECH Dedicated Stylus
- ★ Metal Cabinet with Diverse Combine Options
- ★ Made in Taiwan, 3 Years Warranty, Designed for Harsh Environments
- ★ Optional Anti-Glare&UV/Antibacterial/Privacy Filter Surface Treatment



PSE



BSMI



RoHS



CE



ISO9001



FCC



Desktop Stand



Open-frame Brackets



Wall Mounting



Cart



KIOSK Cabinet

System Specifications

CPU	Intel® Alder Lake-N97 Processor
Memory	DDR4 SO-DIMM 8G, Max to 16G
Network	Intel i210-AT GbE Ethernet Controller x1 Intel i226-V GbE Ethernet Controller x1
Storage	M.2 M-Key 2280, PCIE X1/SATA, Support PCIE X1 NVMe/SATA SSD, Auto Detect SATA3.0 6Gbps
Sound Chip	Realtek Audio HAD Codec
Rear I/O	HDMI x1, DP x1 RJ45 LAN Ports x2 USB 3.0 x4, USB 2.0 x2 RS485 x1, RS232 x6 Line-Out + MIC 2in1 3.5mm Jack x1
Operating Temp.	0~60°C
Storage Temp.	-20~75°C
Power Input	100~240VAC

Display Specifications

Screen Diagonal	32 inch	Display Mode	Normally Black
Display Area	698.4x392.85 mm	Response Time	8 msec.
Resolution	1920x1080 (FHD)	Backlight Unit	LED (white LED)
Contrast Ratio	4000:1	Viewing Angle (L/R, U/D)	178°/178° (CR=10)
Display Ratio	16:9	Backlight Lifetime	>70,000 hours
Support Colors	16.7M Colors	Operating Temp.	-20~60°C
Pixel Pitch	0.3637x0.3637 mm	Storage Temp.	-20~60°C
Brightness	2500 nits		

Touch Options

Touch Screen		
	Description	Model Name
Standard	Projected Capacitive Touch	NTWP320HP4XX-SI97XXX-XXFA-612E
Option	Non-Touch	NTWP320H04XX-SI97XXX-XXFA-612E

Projected Capacitive Touch

Allowed Touch Points	10 points	Thickness of Cover Lens	3.0±0.2mm
Transparency	≥87%	Hardness of Cover Lens	7H
Accuracy	99.00%	IK Ratings	IK07

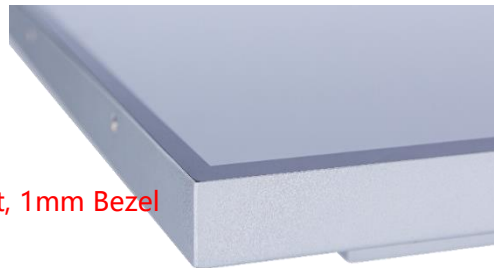

* True Flat, 1mm Bezel

Surface Treatment		
	Description	Model Name
Standard	(none)	NTWP320HX400-SI97XXX-XXFA-612E
Option 1	Anti-Glare&Anti-UV Coating	NTWP320HX4GG-SI97XXX-XXFA-612E
Option 2	Antibacterial (AB Film)	NTWP320HX4AB-SI97XXX-XXFA-612E
Option 3	Anti-Spy (AS Film)	NTWP320HX4SE-SI97XXX-XXFA-612E

Passive Stylus Pen (Option)	
Technology	Passive High Sensitive Knitted Wire Mesh Fiber Tip
Size of tip	6mm
Magnetic Attachment	Yes



Magnetic Attachment >

System Options

Memory		
	Item	Model Name
Standard	DDR4 SO-DIMM 8G	NTWP320HX4XX-SI978XX-XXFA-612E
Option 1	DDR4 SO-DIMM 16G	NTWP320HX4XX-SI97AXX-XXFA-612E
Option 2	DDR4 SO-DIMM 32G	NTWP320HX4XX-SI97BXX-XXFA-612E
Option 3	DDR4 SO-DIMM 64G	NTWP320HX4XX-SI97CXX-XXFA-612E

Storage		
	Item	Model Name
Standard	SSD 128G	NTWP320HX4XX-SIXXXS1-XXFA-612E
Option 1	SSD 256G	NTWP320HX4XX-SI97XS2-XXFA-612E
Option 2	SSD 512G	NTWP320HX4XX-SI97XS3-XXFA-612E
Option 3	SSD 1T	NTWP320HX4XX-SI97XH1-XXFA-612E
Option 4	SSD 128G + SATA HDD 1T	NTWP320HX4XX-SI97XSH-XXFA-612E

Material of Cabinet		
	Description	Model Name
Standard	SECC	NTWP320HX4XX-SI97XXX-SXFA-612E
Option 1	Stainless Steel	NTWP320HX4XX-SI97XXX-LXFA-612E
Option 2	Aluminum	NTWP320HX4XX-SI97XXX-AXFA-612E

Color of Cabinet		
	Description	Model Name
Standard	Silver	NTWP320HX4XX-SI97XXX-XSFA-612E
Option 1	White	NTWP320HX4XX-SI97XXX-XWFA-612E
Option 2	Black	NTWP320HX4XX-SI97XXX-XBFA-612E
Options	Other Colors	NTWP320HX4XX-SI97XXX-XXFA-612E

* X = A~Z, 0~9 (Depends on Color)

Input /Output System

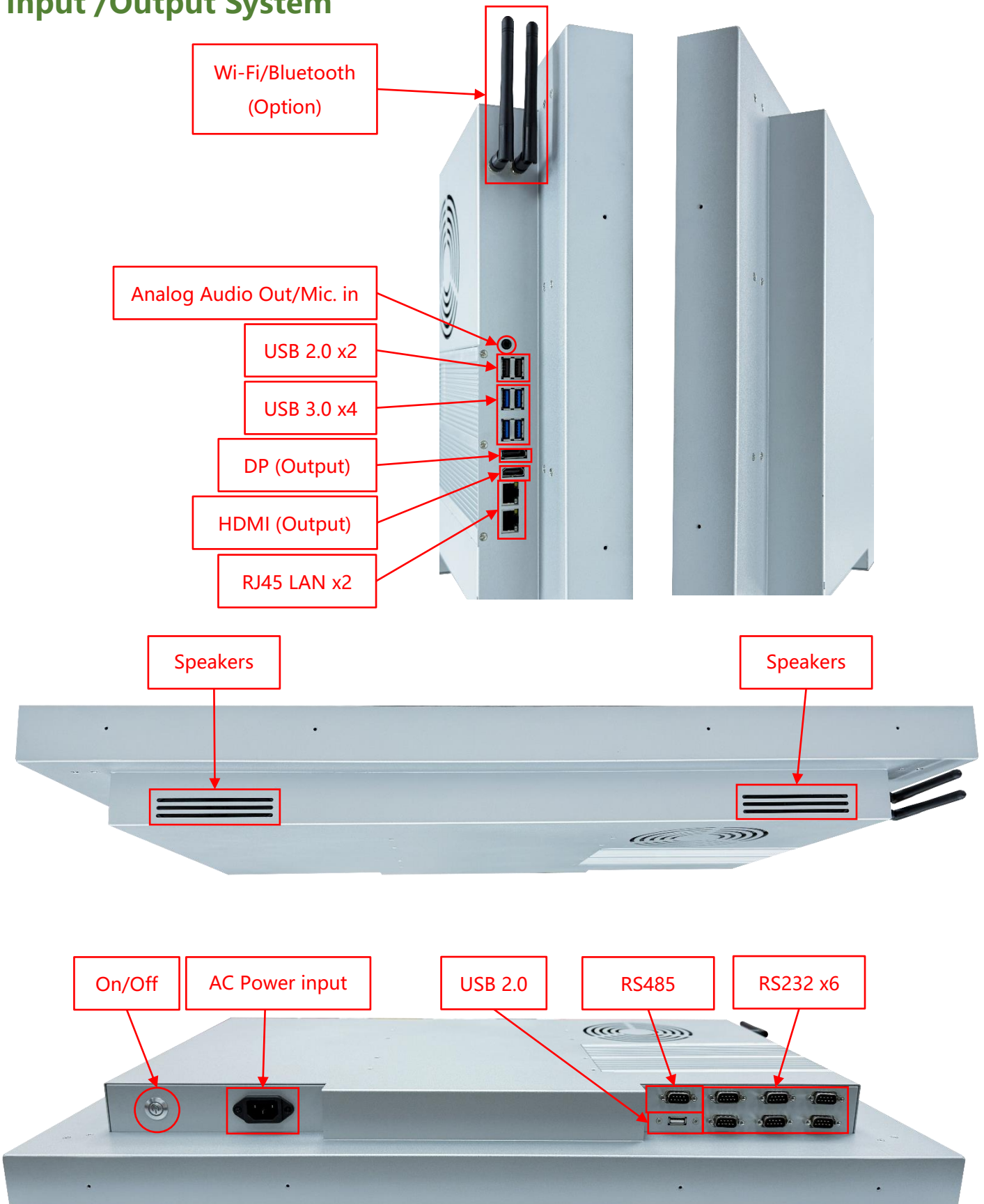

Nextech WP Series 32" Industrial All-in-one Touch PC

NTWP320-4 V612E

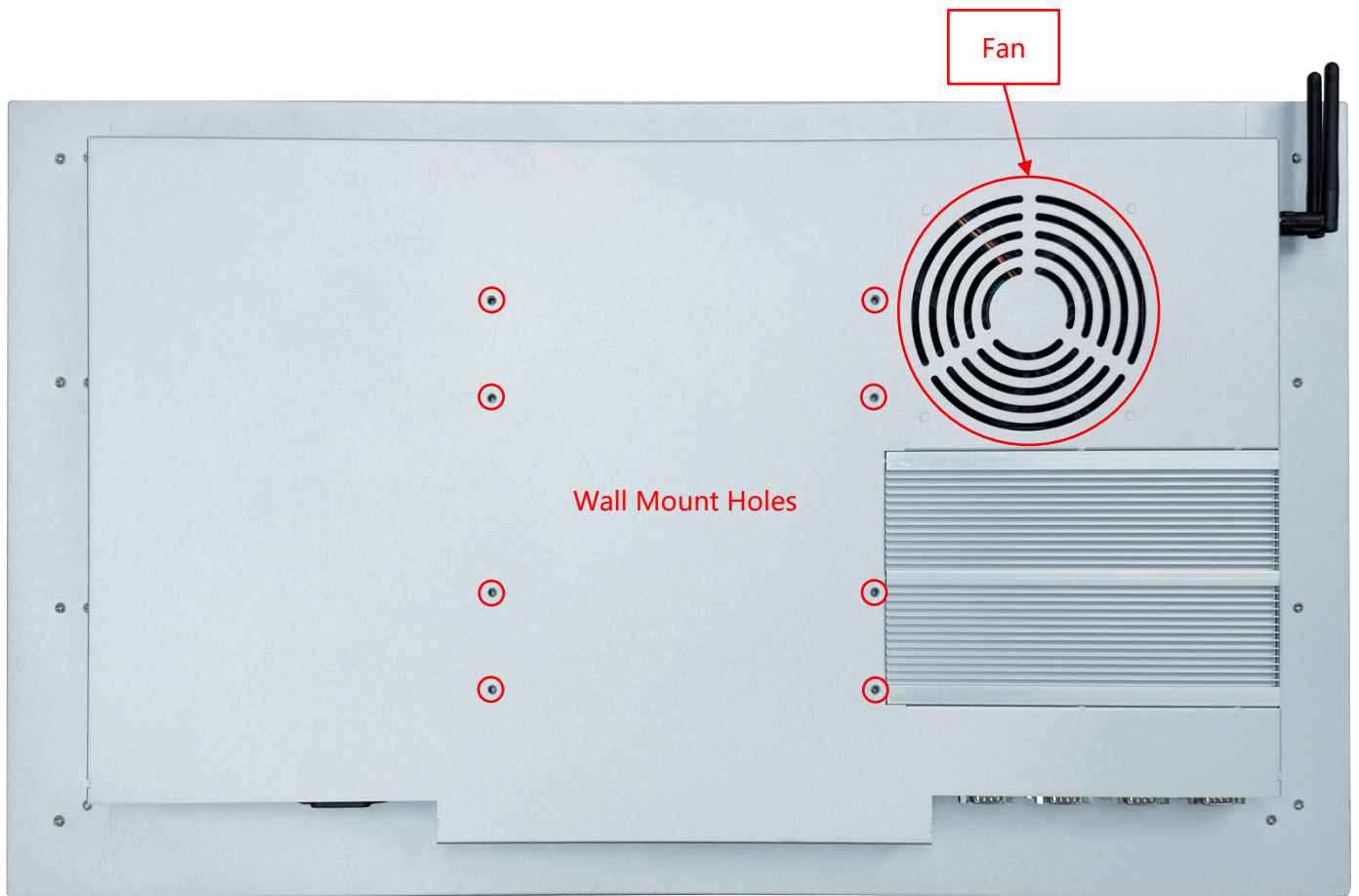

Input / Output	Connectors	Input / Output	Connectors
HDMI (Output)	1	LAN (RJ45)	2
DP (Output)	1	Analog Audio Out/Mic. in	1
USB 3.0	4	Speakers	10W x2
USB 2.0	3	AC Power Input	1
RS485	1	Wi-Fi/Bluetooth & Antenna	Option
RS232	6		

Front Cover (Option)

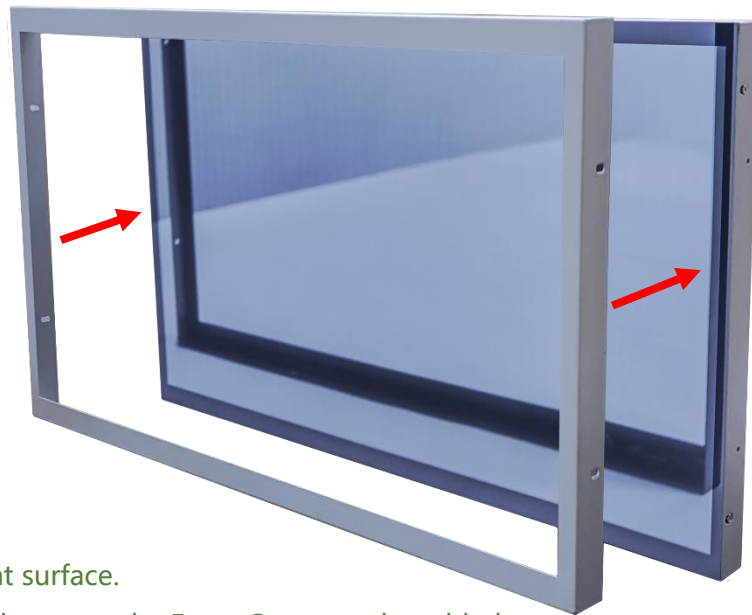

The standard **NTWP320** is true flat surface.

To protect the corners of the touch screen, the Front Cover can be added.



The watertight gasket can be added between the Front Cover and **NTWP320**.

It complies **IP65** on front.

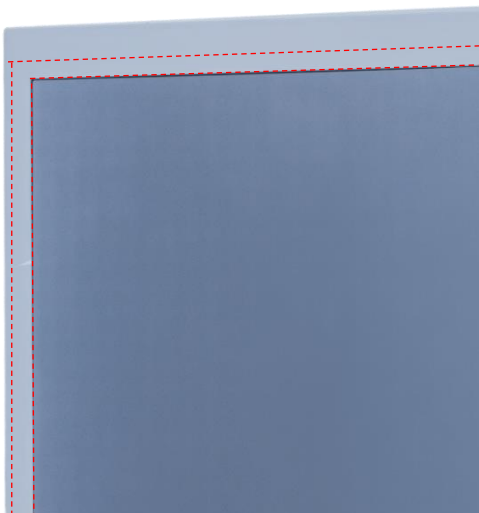

Desktop Stand (Option)

Item	T Stand	Part No.	DST-1B007
Mounting Pattern	200x100/100x100/75x75 mm	Dimension (WxHxD)	508(W)x307(D)x470(H) mm
Material	Steel/Plastic/Aluminum	Net Weight	2.44 KG
Tilt (Hinge)	+/-15°	Support Max. Weight	15 KG

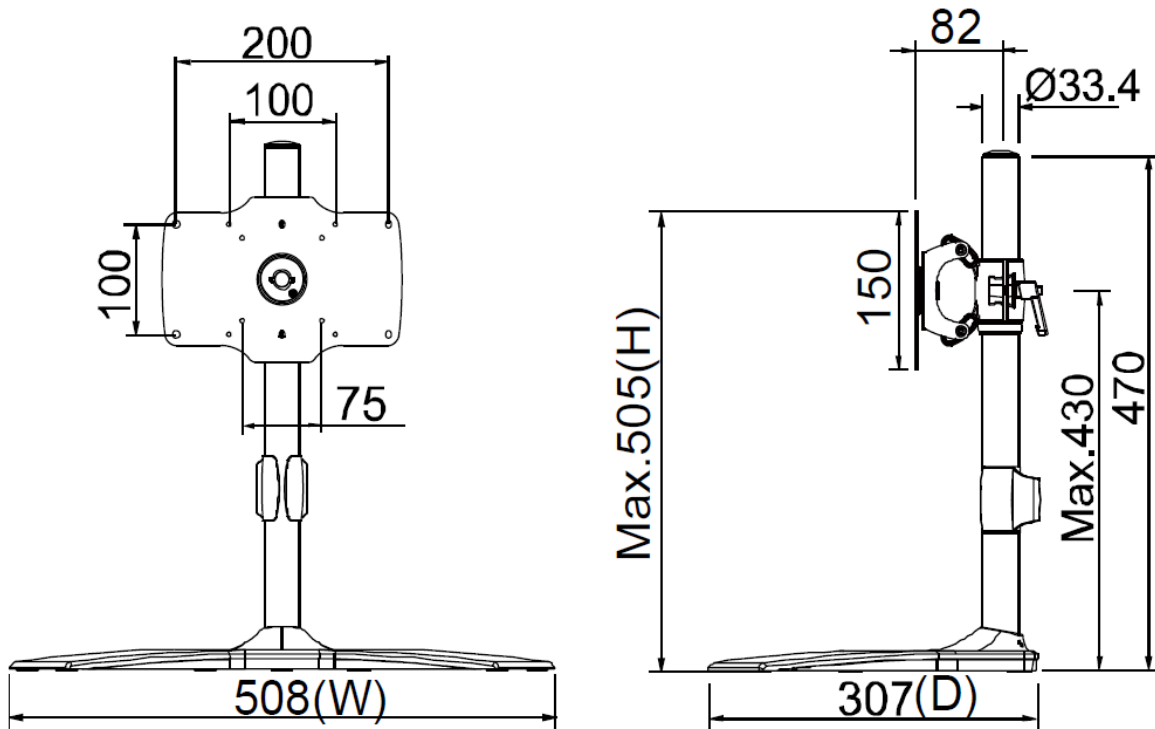

Wall Mount Bracket (Option)

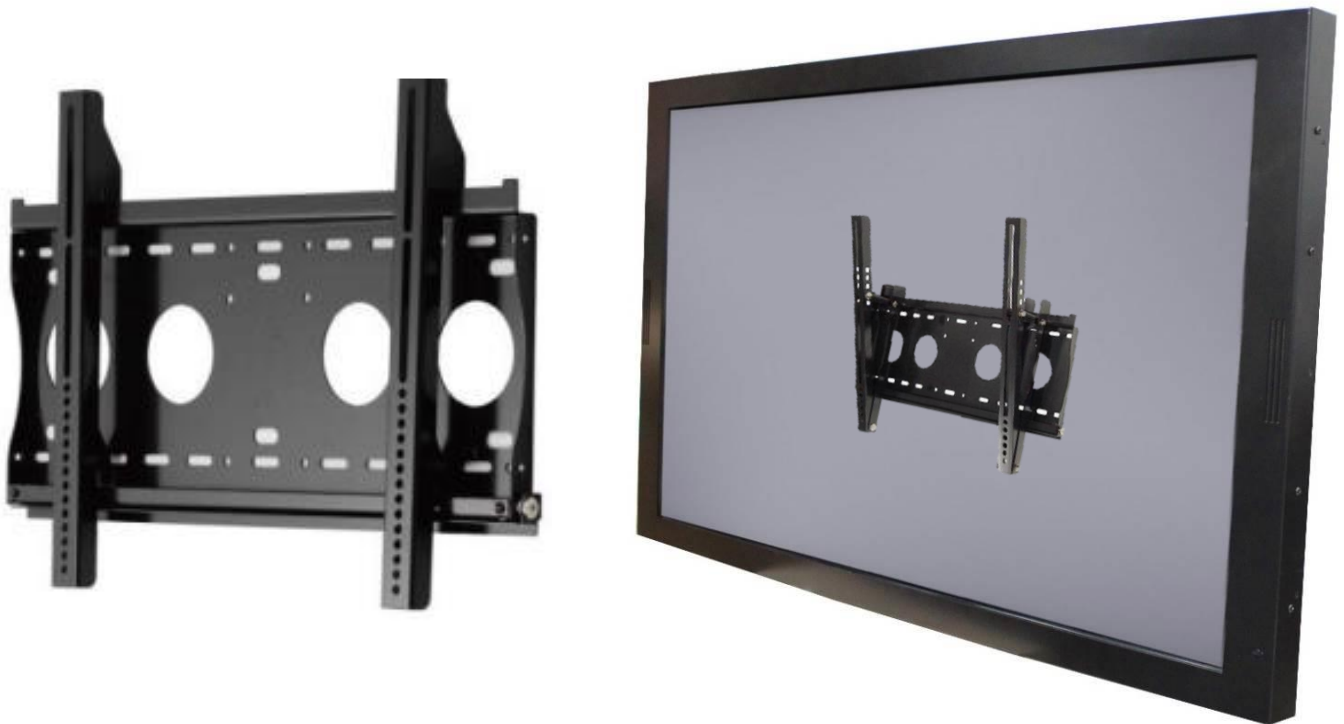

Part No.	WMB-B001		
Mounting Pattern	Max. 400x450 mm	Mounting Pattern	Max. 400x450 mm
Material	SECC	Material	SECC
Tilt (Hinge)	0°/5°/10°/13°/15°	Tilt (Hinge)	0°/5°/10°/13°/15°
Screw Type	M4/M5/M6/M8	Screw Type	M4/M5/M6/M8

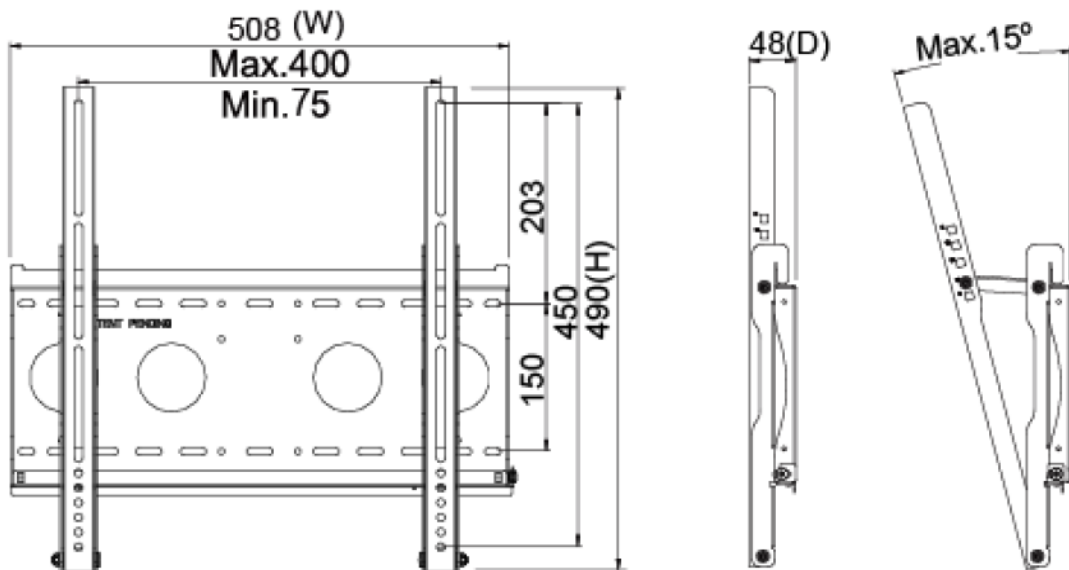

Nextech WP Series 32" Industrial All-in-one Touch PC

NTWP320-4 V612E

Cart (Option)



Net Weight	28.4 KG
Power System	AC 200~240V 50/60Hz
User Interface	Button (up/down)
Packaged Dimension	W1160xD833xH1727 mm
Screw Type	M4/M5/M6/M8
Material	Aluminum/Plastic/Steel
Max. Mount Pattern	800x600mm
Max. Weight Load	80 KG
Caster	4 (front 2 braking)
Height Adjust Range	455 mm
RoHS/REACH	Yes

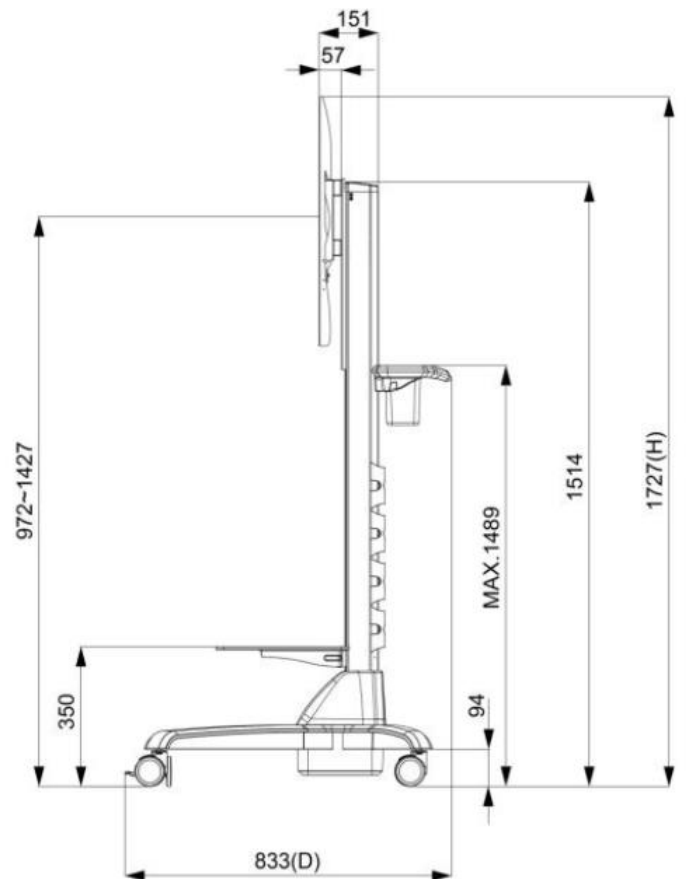
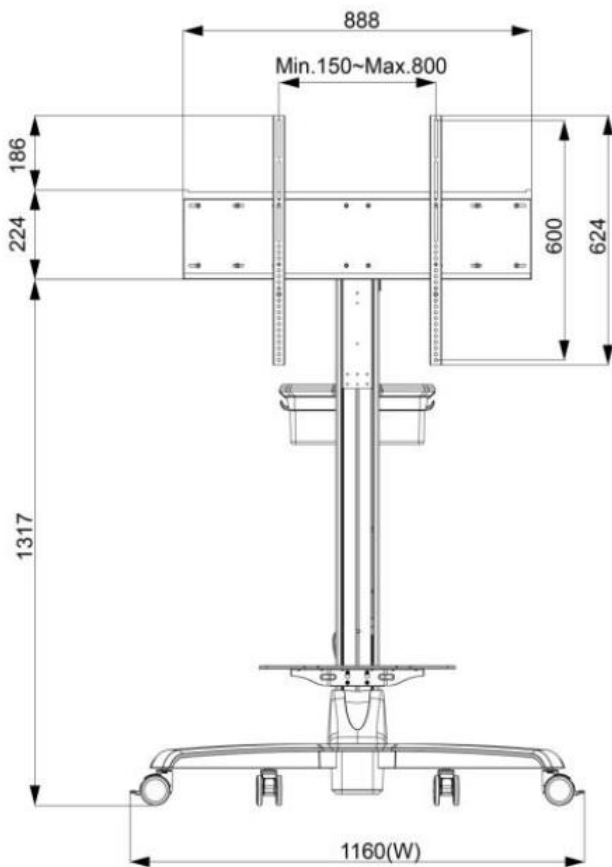

KIOSK Cabinet (Option)



Material	SECC
Caster	4 (front 2 braking)
Ingress Protection	Front IP65
Power Socket	None (Wire Hole Reserved)



Packing Information



Dimensions of Carton	105x24x68 CM
Net Weight	≤ 13.5 KG
Gross Weight	≤ 16.9 KG